



บริษัท เอดีดี เฟอร์เนส จำกัด

ADD FURNACE CO.,LTD.

44 ซอยบรมราชชนนี 70 ถนนบรมราชชนนี แขวงศาลาธรรมสพน์ เขตทวีวัฒนา กรุงเทพฯ 10170

โทร: 02-888-3472 โทร.)ออกแบบ:(08-08-170-170 แฟกซ์: 02-888-3258

<https://www.add-furnace.com> E-mail: sales@add-furnace.com

azbil

No. CP-SP-1264E

Dynamic Self-Checking Burner Controller Model AUR450C User's Manual



Thank you for purchasing an Azbil Corporation product.

This manual contains information for ensuring the correct use of this product. It also provides necessary information for installation, maintenance, and troubleshooting.

This manual should be read by those who design and maintain equipment that uses this product. Be sure to keep this manual nearby for handy reference.

Azbil Corporation



บริษัท เอดีดี เฟอร์เนส จำกัด

ADD FURNACE CO.,LTD.

44 ซอยบรมราชชนนี 70 ถนนบรมราชชนนี แขวงศาลาธรรมสพน์ เขตทวีวัฒนา กรุงเทพฯ 10170

โทร: 02-888-3472 โทร.ออกแบบ:(08-08-170-170 แฟกซ์: 02-888-3258

<https://www.add-furnace.com> E-mail: sales@add-furnace.com

NOTICE

Be sure that the user receives this manual before the product is used.

Copying or duplicating this user's manual in part or in whole is forbidden. The information and specifications in this manual are subject to change without notice.

Considerable effort has been made to ensure that this manual is free from inaccuracies and omissions. If you should find an error or omission, please contact the azbil Group.

In no event is Azbil Corporation liable to anyone for any indirect, special or consequential damages as a result of using this product.

© 2007–2019 Azbil Corporation. All Rights Reserved.



บริษัท เอดีดี เฟอร์เนส จำกัด

ADD FURNACE CO.,LTD.

44 ซอยบรมราชชนนี 70 ถนนบรมราชชนนี แขวงศาลาธรรมสพน์ เขตทวีวัฒนา กรุงเทพฯ 10170

โทร: 02-888-3472 โทร.)ออกแบบ:(08-08-170-170 แฟกซ์: 02-888-3258

<https://www.add-furnace.com> E-mail: sales@add-furnace.com

Conventions Used in This Manual

„ The safety precautions explained in the following section aim to prevent injury to the operator and others, and to prevent property damage.

 **WARNING**

Warnings are indicated when mishandling this product might result in death or serious injury.

 **CAUTION**

Cautions are indicated when mishandling this product might result in minor injury to the user, or physical damage to the product.

„ In describing the product, this manual uses the icons and notations listed below.



Use caution when handling the product.



The indicated action is prohibited.



Be sure to follow the indicated instructions.



Handling Precautions:

Handling Precautions indicate items that the user should pay attention to when handling this device.



Note:

Notes indicate information that might benefit the user.

(1), (2), (3):

Numbers within parentheses indicate steps in a sequence or parts of an explanation.



This indicates the item or page that the user is requested to refer to.



บริษัท เอดีดี เฟอร์เนส จำกัด

ADD FURNACE CO.,LTD.













44 ซอยบรมราชชนนี 70 ถนนบรมราชชนนี แขวงศาลาธรรมสพน์ เขตทวีวัฒนา กรุงเทพฯ 10170

โทร: 02-888-3472 โทร.) ออกแบบ:(08-08-170-170 แฟกซ์: 02-888-3258

https://www.add-furnace.com E-mail: sales@add-furnace.com

Safety Precautions

WARNING

-  This device does not have a prepurge function. Use this device as part of a system whose design gives careful consideration to the prepurge timer and ignition sequence timing, following established safety guidelines.
-  Connect loads (ignition transformer, solenoid valve, etc.) directly to the output terminals of this device. Otherwise, combustion safety cannot be ensured.
When using an auxiliary relay due to lack of contact capacity, etc., take protective measures in case a relay malfunction or contact welding occurs.
-  Never short-circuit the start contact in order to start and stop this device by switching the power on and off. This is very important for reliable activation of the self-check circuit at device startup. Failure to observe this warning could lead to an explosion.
-  Do not extend the lead wires of the reset input for more than the allowable length of 10 meters. Always input the reset command from beside the combustion equipment, not from a remote location. Because a safety check cannot be made far from the equipment, there is an increased risk of explosion.
-  Do not allow the pilot or main burner "Safety Time" (ignition trial time) to exceed the specifications of the burner or equipment manufacturer. If they do, fuel may accumulate in the combustion chamber and form an explosive air-fuel mixture, resulting in a serious explosion hazard.
-  Before wiring, mounting, or removing this device, be sure to turn the power off. Wiring with the power on can result in an electric shock.
-  Make sure that the AUD300C/500C does not detect ultraviolet rays other than those of the burner. If the AUD300C/500C responds to other ultraviolet rays, flame failure in the burner will not be detected. As a result, fuel will continue to be discharged, causing a serious explosion hazard.
-  Do not connect a solenoid valve to the high voltage side of the circuit. If a ground fault occurs, the ground fault current may energize and open the solenoid valve. This device will not be able to prevent the valve from opening and fuel from flowing out.
-  Terminals and the connected flame detector signal cable retain an electrical charge even after the power is turned OFF. To avoid electric shock, do not touch terminals F and G or the cable immediately after power-off.
-  Carry out the pilot turndown test carefully. If the flame detector is set so that it detects a pilot flame that is too small to ignite the main burner, this device will not be able to detect a flame failure in the main burner.
In that case, fuel will continue to be supplied, causing a serious explosion hazard.
-  Before the pilot turndown test or ignition spark response test, make sure that all manual fuel valves are closed.
-  If the pilot turndown test must be carried out repeatedly, completely shut down all equipment each time the test is finished, and completely discharge unburned gas or fuel that has accumulated in the ducts and combustion chamber. Failure to discharge unburned gas or fuel may result in an explosion.





WARNING

 When the pilot turndown test is complete, turn OFF the power switch to shut down the power. Restore all test jumpers and limit interlock/regulator settings to their previous states. If operation begins without the above steps, damage to the equipment, gas leak or explosion may result.

 If lockout occurs, be sure to do a prepurge before restarting the system. If the combustion chamber and gas flue are not ventilated to remove any unburned gas, the ignition process may cause an explosion.

 If a check is performed using a flame simulator without dismounting this device, be sure to close the fuel valve. When a flame simulator is used during normal operation, the flame detector reports that a flame is present even if the pilot burner and main burner are not ignited, with the result that fuel is supplied continuously. This could cause an explosion.

 This device has a limited product life. Beyond the product life, the risk of device failure becomes higher. Replace this device within its product life.

 If the system is locked out, do not reset it until the cause of the problem has been eliminated.

 If lockout occurs, reset it only after removing the cause. Also, do not enter reset input repeatedly.
Operating this product improperly could result in a serious combustion equipment accident.

 Do not use the alarm output as safety output.

CAUTION

 Be sure to use this device correctly, within the ranges specified in this user's manual. Otherwise device failure or malfunction could result.

 Do not install where exposed to any of the following:

- Certain chemicals or corrosive gases (ammonia, sulfur, chlorine, ethylene compounds, acid, etc.).
- Splashing water or excessive humidity.
- High temperatures.
- Prolonged vibration.

 This device has a protective structure equivalent to IP20. Take measures to protect it from dust. In particular, if the equipment is designed to comply with CE/UL standards, be sure to mount this device in an instrument panel with IP54 or equivalent protection.

 Installation, wiring, inspection, adjustment, etc. should be carried out by a trained and experienced technician who has knowledge and technical skills related to combustion equipment and flame safeguard control devices.

 Do not start regular operation of the equipment without first completing the trial-run adjustments for this device, as well as the tests specified by the equipment manufacturer.



CAUTION



Make sure the load connected to each terminal does not exceed the rating indicated in the specifications.



If timers and auxiliary relays are needed for additional functions, select ones with high reliability, and be sure to design the circuit correctly.



When installing and wiring, be sure to follow the instructions in this manual and in the user's manual for the combustion equipment.



The ignition transformer ground lead should be connected directly to the burner body or to a metallic part electrically connected to the burner body.



Run the high-voltage ignition transformer cable separately and keep it at least 10 cm away from this device.



Keep power lines and ignition transformer high-voltage cables separate from the AUD300C/500C cables and from the external reset input cable.



Make sure that ignition transformer high-voltage cables are properly connected to prevent faulty contact. Faulty contact might generate high-frequency radio waves which can cause malfunction.



Always connect the power supply last. Otherwise, touching a terminal accidentally could result in electric shock or damage.



Always supply electric power at the voltage and frequency stated on the model label of this device.



In keeping with technical standards for electrical equipment, the burner body must have an earth ground connection with a resistance of less than 100 Ω .



After the wiring is complete, be sure to check that it is correct. Incorrect wiring may cause damage or faulty operation.



Make sure that the flame detector does not detect the ignition spark. If the flame detector can detect the spark, change the detector's line of sight or change the ignition electrode's position.



Only an experienced technician who has knowledge and technical skills related to combustion equipment and combustion safety should carry out the pilot turndown test.



This product is equipped with functions that are extremely important for the safe operation of combustion equipment. Carefully follow the instructions for its use that are given in this user's manual.



If the safety shutoff has been activated, check all of the items on the checklists in chapter 4, TRIAL-RUN ADJUSTMENT before restarting the equipment.



When doing a maintenance inspection of the burner, be sure to do the pilot turndown test. Inspection must be done at least once a year.

Conduct periodic inspections in accordance with the user's manual of the equipment manufacturer.



บริษัท เอดีดี เฟอร์เนส จำกัด

ADD FURNACE CO.,LTD.

44 ซอยบรมราชชนนี 70 ถนนบรมราชชนนี แขวงศาลาธรรมสพน์ เขตทวีวัฒนา กรุงเทพฯ 10170

โทร: 02-888-3472 โทร.ออกแบบ:(08-08-170-170 แฟกซ์: 02-888-3258

<https://www.add-furnace.com> E-mail: sales@add-furnace.com

CAUTION



When cleaning the burner, clean the flame detector as well.



For transportation or storage of this device, remove it from the subbase and pack it in its original box. It might be damaged if transported while mounted on a panel or the like.



Do not short the control load terminals (18-19, 18-20, 18-21, or 18-22) or the shutter terminals (7-8). Internal fuses between these terminals will burn out if these terminals are shorted.

If a fuse burns out, replace the entire product.



บริษัท เอดีดี เฟอร์เนส จำกัด

ADD FURNACE CO.,LTD.

44 ซอยบรมราชชนนี 70 ถนนบรมราชชนนี แขวงศาลาธรรมสพน์ เขตทวีวัฒนา กรุงเทพฯ 10170

โทร: 02-888-3472 โทร.) ออกแบบ:(08-08-170-170 แฟกซ์: 02-888-3258

https://www.add-furnace.com E-mail: sales@add-furnace.com

The Role of This Manual

A total of 8 different manuals are available for the AUR450C. Read them as necessary for your specific requirements.

If a manual you require is not available, contact the azbil Group or its dealer.

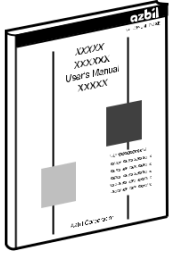

Dynamic Self-Checking Burner Controller Model AUR450C User's Manual Manual No. CP-SP-1264E

This manual.

This manual should be read by personnel using the AUR450C for the first time, those in charge of designing combustion equipment that uses the AUR450C or designing the hardware for mounting the device in a control panel, and personnel performing maintenance.

The manual gives an overview of the product, its mounting and wiring for connection to other equipment, its operation, trial-run adjustment, maintenance and inspection, and specifications.

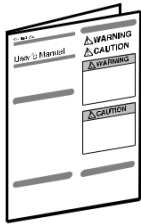

Dynamic Self-Checking Burner Controller Model AUR450C **User's Manual for Installation** Manual No. CP-UM-5936JE

This manual is supplied with model AUR450C. Those who design or maintain equipment that uses the AUR450C should read this manual thoroughly. This manual describes installation of this device.

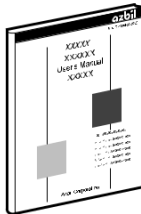

Dynamic Self-Checking Burner Controller Model AUR450C User's **Manual for Communication** Manual No. CP-SP-1176E

Those using the communications functions of the AUR450C should read this manual.

It is necessary for making the program of the device that uses AUR450C. An operation status and various data of AUR450C can be read by using the communication.

This manual describes a details of display, outline of CPL communications, communications procedures, a list of communications data, how to remedy trouble, and communications specifications.

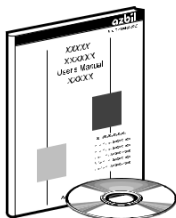

User's Manual for Smart Loader Package Model SLP-A45 for **Dynamic Self-Checking Burner Controller Model AUR450C** Manual No. CP-SP-1187E

This manual is supplied with the SLP-A00 Smart Loader Package.

The manual describes the software used to make various settings for smart loader package using a personal computer. Personnel in charge of design or setup of a system using the AUR450C must thoroughly read this manual.

The manual describes installation of the software into a personal computer, operation of the personal computer, various functions, and setup procedures.



บริษัท เอดีดี เฟอร์เนส จำกัด

ADD FURNACE CO.,LTD.

44 ซอยบรมราชชนนี 70 ถนนบรมราชชนนี แขวงศาลาธรรมสพน์ เขตทวีวัฒนา กรุงเทพฯ 10170

โทร: 02-888-3472 โทร.ออกแบบ:(08-08-170-170 แฟกซ์: 02-888-3258

<https://www.add-furnace.com> E-mail: sales@add-furnace.com

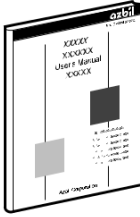

Advanced Ultraviolet Flame Detector Model AUD300C1000 User's Manual
Manual No. CP-SP-1141E

The manual describes the mounting, wiring, maintenance and inspection, and troubleshooting when the AUD300C1000 when it is used in a safeguard control system.

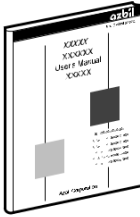

Explosion-Proof Advanced Ultraviolet Flame Detector Model
AUD500C11000 User's Manual

Manual No. CP-SP-1328E

It describes the mounting, wiring, maintenance, inspection, and troubleshooting of the AUD500C when it is used with combustion equipment.

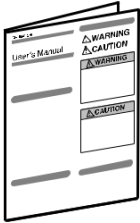

User's Manual for Subbase Model Q241A104 for Dynamic Self-Checking Burner Controller Model AUR450C

Manual No. CP-UM-5942JE

This manual is supplied with the subbase. Those who design or manufacture equipment that uses the AUR450C should read this manual thoroughly. The subbase is necessary when installing the AUR450C in a panel, etc. This manual describes installation and wiring of the subbase.



Analog Flame Meter Model FSP136A User's Manual

Manual No. CP-SP-1212E

It should be read in advance by those who use the FSP136A to check the voltage of the AUR300C/350C/450C. This manual gives important information and precautions for use of the meter.



บริษัท เอดีดี เฟอร์เนส จำกัด

ADD FURNACE CO.,LTD.

44 ซอยบรมราชชนนี 70 ถนนบรมราชชนนี แขวงศาลาธรรมสพน์ เขตทวีวัฒนา กรุงเทพฯ 10170

โทร: 02-888-3472 โทร.) ออกแบบ:(08-08-170-170 แฟกซ์: 02-888-3258

<https://www.add-furnace.com> E-mail: sales@add-furnace.com

Organization of This User's Manual

This manual is organized as follows.

Chapter 1. OVERVIEW

An overview of the AUR450C.

Chapter 2. MOUNTING AND WIRING

Installation, wiring and wiring check methods.

Chapter 3. OPERATION

Internal block diagram of the AUR450C and sequence charts showing its operation.

Chapter 4. TRIAL-RUN ADJUSTMENT

Adjustment of the AUR450C and tests that are necessary before operating it.

Chapter 5. MAINTENANCE AND INSPECTION

Maintenance and inspection instructions, and troubleshooting flowchart.

Chapter 6. SPECIFICATIONS

General specifications, performance specifications, and external dimensions of the AUR450C.



Contents

Conventions Used in This Manual

Safety Precautions

The Role of This Manual

Organization of This User's Manual

Chapter 1. OVERVIEW	1-1
„ Overview	1-1
„ Features	1-1
„ System structure	1-2
„ Safety assurance functions	1-2
„ Precautions for designing equipment	1-3
„ Model selection table	1-3
„ Related devices	1-4
„ Certificates	1-4
„ Names and functions of parts	1-4
„ Description of 7-segment display	1-6
„ Terminal block signals	1-8
Chapter 2. MOUNTING AND WIRING	2-1
2-1 Mounting	2-1
„ Mounting locations	2-1
„ Mounting posture	2-2
„ Mounting the subbase	2-2
„ Mounting the controller	2-3
„ Dismounting the controller	2-3
2-2 Wiring	2-4
„ Wiring diagram	2-5
„ Connection to the Model AUD300C/500C	2-7
„ Checking the connection between the controller and the Model AUD300C/500C	2-7
„ Wiring to a solenoid valve	2-8
„ Wiring for continuous measurement of flame voltage	2-9
2-3 Communications Connections	2-11
„ Smart Loader connection	2-11
„ Connection of RS-485 communications	2-11
„ Connection to a 3-wire system	2-12
„ Connection to a 5-wire system	2-12
Chapter 3. OPERATION	3-1
„ Example of instrumentation for the Model AUR450C with an interrupted pilot	3-1
„ Precautions for instrumentation and circuit configuration with an interrupted pilot	3-1
„ Internal block diagram	3-2
„ Sequence charts	3-3



บริษัท เอดีดี เฟอร์เนส จำกัด

ADD FURNACE CO.,LTD.

44 ซอยบรมราชชนนี 70 ถนนบรมราชชนนี แขวงศาลาธรรมสพน์ เขตทวีวัฒนา กรุงเทพฯ 10170

โทร: 02-888-3472 โทร.) ออกแบบ:(08-08-170-170 แฟกซ์: 02-888-3258

<https://www.add-furnace.com> E-mail: sales@add-furnace.com

„ Example of instrumentation for the Model AUR450C with an intermittent pilot —	3-10
„ Precautions for instrumentation and circuit configuration with an intermittent pilot _____	3-10
„ Internal block diagram _____	3-11
Chapter 4. TRIAL-RUN ADJUSTMENT _____	4-1
„ Outline of adjustment _____	4-1
„ Preliminary inspection _____	4-2
„ Measurement of flame voltage (flame signal) _____	4-2
„ Pilot turndown test _____	4-3
„ Ignition spark response test _____	4-5
„ Safety shutoff test _____	4-6
Chapter 5. MAINTENANCE AND INSPECTION _____	5-1
„ Frequency of maintenance and inspection _____	5-1
„ Alarm code and description _____	5-2
„ Fault inspection flowchart _____	5-3
Chapter 6. SPECIFICATIONS _____	6-1
„ Specifications _____	6-1
„ External dimensions _____	6-3
„ China RoHS _____	6-3
Terms and Conditions	



Chapter 1. OVERVIEW

„ Overview

The AUR450C Dynamic Self-Checking Burner Controller (hereafter the/this device) is a flame safeguard controller that safely and automatically ignites and monitors a gas or oil burner using the correct sequence of steps. It executes both batch and continuous operations in combination with the AUD300C Advanced Ultraviolet Flame Detector or the AUD500C Explosion-Proof Advanced Ultraviolet Flame Detector.

This device monitors combustion while continuously checking the tube unit of the AUD300C/500C and the flame detection circuits by driving the shutter of the AUD300C/500C.

The device has a 7-segment display and communications function. Flame voltage, sequence status and alarm codes are displayed. For effective maintenance and troubleshooting, a personal computer can be used to read data such as the system status before the occurrence of various errors, past alarm history, operation time, and number of combustion starts.

„ Features

1. Safety standards

* Self-declaration of conformity to standards is not permitted for combustion safety equipment.

This product is certified to meet standards as noted below.

- UL: File No. MH27717
- CE: Gas Appliance Directive 0063BS1427
- FM: File No. 0003059531

2. Ignition sequence

Either 4-second or 8-second “Safety Time” (ignition trial time) is selectable by model number. Either an intermittent or an interrupted pilot can be used, se-lectable by output terminal.

3. Instrumentation and handling

This model requires less mounting space than a conventional model because of its compact design. Since wiring can be done at the subbase, mounting or dis-mounting the controller can be done with ease.

Flame monitoring output and alarm output contacts can be used as independent non-voltage contacts. There is an input terminal for remote reset, or reset can be done from the operating panel.

4. Display function

The LED indicators, which are especially useful for maintenance and trouble-shooting, can be used to check the progress of the ignition sequence, the status of flame detection, alarms, and the occurrence of events.

The LED indicators change color (green/orange/red) depending on the flame voltage level. The 7-segment display is used to check sequence codes, alarm codes, and event code



Chapter 1. OVERVIEW

„ System structure

This device is used to control the flame of combustion equipment, and is used in a system like the one shown below.

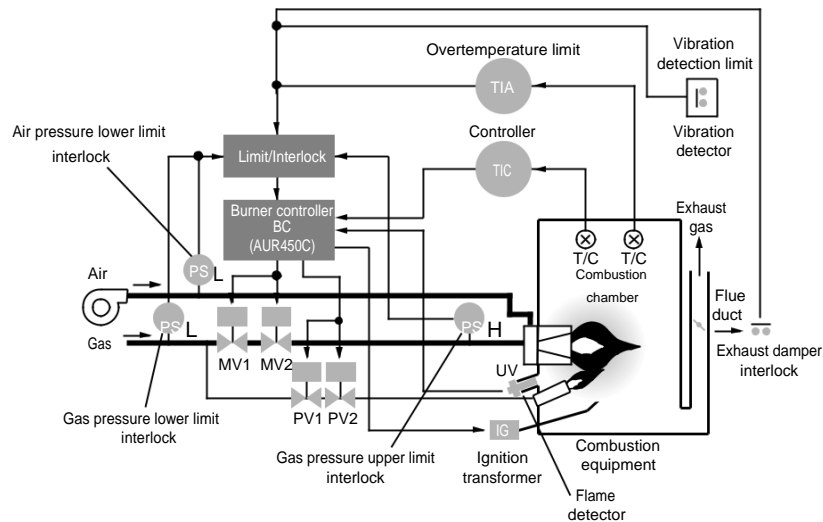

„ Safety assurance functions

This device performs functions that are vital for burner operation and flame monitoring.

- **Combustion monitoring and safety shutdown**
 - Detects burner flame failure and shuts down the fuel supply immediately.
 - In case of ignition failure or flame failure, shut down each valve ignition transformer in a predetermined sequence.
- **Startup, operation and shutdown of combustion equipment**
 - Operates each valve ignition transformer in a predetermined order, with preset timing.
- **Fixed ignition timing**
 - To ensure safety, the ignition circuit is so designed that ignition cannot continue in excess of the specified time, even if part of the ignition circuit fails.
- **Safe startup**
 - Checks flame detector and flame circuit for internal failure before every startup.
 - If failure is detected, prevents burner startup.
 - Checks for false flame detection or false discharge of the tube unit, failure of the ignition circuit, and failure of the alarm circuit.
- **Flame safeguard control in compliance with safety standards**
 - This controller's design is based on North American and European safety standards, and it is certified to meet them. This device can be used with combustion safety equipment in Europe and North America.
- **Dynamic self-checking**
 - Checks continuously for sensor failure of the AUD300C/500C and for failure of the flame detection circuit, even during the RUN stage of operation. If failure is detected, fuel supply shutdown and lockout are immediately carried out.
- **Protection against part failure**
 - Failure Mode Effect Analysis (FMEA) has been done for all parts. Even if a part failure occurs, safety will be maintained, and dangerous conditions such as the following will not occur:
 - Out-of-order ignition sequence.
 - Dangerous sequence timing (longer ignition time)



„ Precautions for designing equipment

When designing facilities that include combustion safety equipment, take the safety directives listed below into careful consideration.

- Safety Engineering Directives for Industrial Heating Furnace Combustion Equipment (Health, Labor and Welfare Ministry)
- General Safety Code for Industrial Combustion Furnaces (= JIS B 8415)
- Safety Engineering Directives for Industrial Gas Combustion Equipment (The Japan Gas Association)
- Safety Guideline for Gas Boiler Combustion Equipment (The Japan Gas Association)
- In the U.S.: Combustion Safety Guidelines (National Fire Protection Association, NFPA86)
- Europe: EN 746 (Industrial Thermoprocessing Equipment) 93/68/EEC (CE Marking Directive) amending Appliances Burning Gaseous Fuels.

Be sure to refer to the laws and standards of the relevant country when designing equipment.

⌘z Important safety points

- Directly connect the load to this device.
- Structure the interlock so that power to the load can be directly turned off.
- Use the start check circuit during startup (do not short out the start contact input).
- Do not make a manual operation circuit or other bypass circuit for any load.
- Use a redundant shutdown system for both main valve and pilot valve.

⌘z Precautions for system design

Use external equipment to make a purge function, taking into consideration the purge conditions and time settings.

„ Model selection table

The following shows the model selection table for this device:

Basic model No.	Safety time	Standards compliance	Flame failure response time	Power supply	Additional processing 1	Additional processing 2	Description
AUR450C							Dynamic self-checking burner controller
	4						4±1 s
	8						8±2 s
		2					With standards compliance
			2				1.5 s Nominal (2 s maximum)
				3			3 s Nominal (4 s maximum)
					1		100 V AC CE, UL, FM standards
					2		200 V AC CE, FM standards
					3		120 V AC CE, UL, FM standards
					5		230 V AC CE, FM standards
						0	-
							00 Standard (no add. processing)
						D0 Inspection certificate	
						T0 Tropicalization	
						DT Inspection certificate and tropicalization	



Chapter 1. OVERVIEW

„ Related devices

The table below shows the devices that can be used with this device.

Item	Name	Model No. or parts No.	Remarks
Compatible base	Subbase	Q241A104	-20 to +60 °C AWG14 to 18
Compatible flame detector	Advanced Ultraviolet Flame Detector	AUD300C	-20 to +120 °C IV wire 2.0 mm ²
		AUD500C (explosion-proof)	-20 to +60 °C 0.75 mm ² cable with silicone rubber insulation
Optional parts	Flame simulator	FSP300BC100	-
	Analog flame meter	FSP136A100	-
	Surge absorber	83968019-001	-
	Communications connector	81446848-001	1 piece
Loader	Smart loader package	SLP-A00J50	-

„ Certificates

- UL: File No. MH27717
- CE: Gas Appliance Directive (2009/142/EC) 0063BS1427
Low Voltage Directive (2014/35/EU)
Electromagnetic compatibility Directive (2014/30/EU) RoHS Directive (2011/65/EU)
- FM: File No. 0003059531

Certificates are valid only for a combination of AUR450C, AUD300C, and Q241A104.

„ Names and functions of parts

⌘ Controller

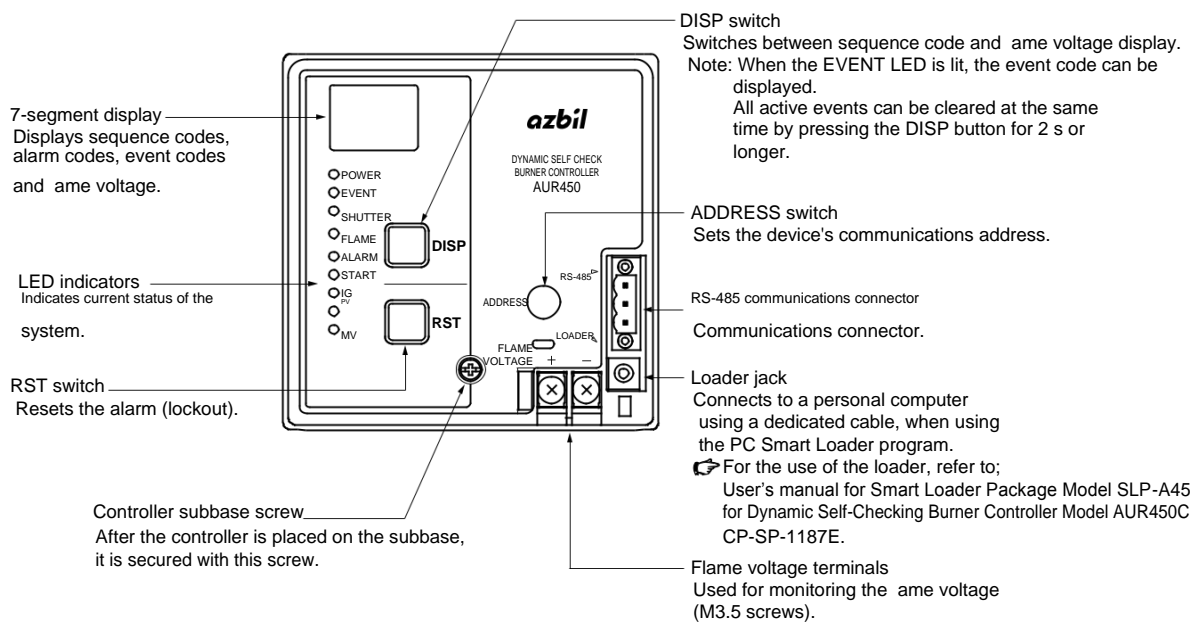

Note

- There are covers on the RS-485 communications connector, loader jack, and flame voltage terminals. For purposes of explanation, covers are not shown in the above drawing.



Chapter 1. OVERVIEW

LED display details

Name	Color	Description
POWER	Green	Lights up when the power is turned on
EVENT	Orange	Lights up when an event occurs
SHUTTER	Green	Lights up when the shutter is closed
FLAME	Green *	Lights up when a flame is detected
ALARM	Red	Lights up when there is an alarm
START	Green	Lights up when the start contact circuit is closed, and goes off when an alarm is detected
IG	Green	Lights up when the ignition transformer output is on
PV	Green	Lights up when the interrupted pilot valve opening output is on
MV	Green	Lights up when the main valve opening output is on

* On the device, the color changes to green, orange or red as determined during setup. The factory settings are green for a flame voltage of 2.5 V or more, orange for 1.6 to 2.4 V, and red for 1.5 V or less. The LED goes off if no flame is detected (K6 is off).

Subbase (Q241A104) sold separately

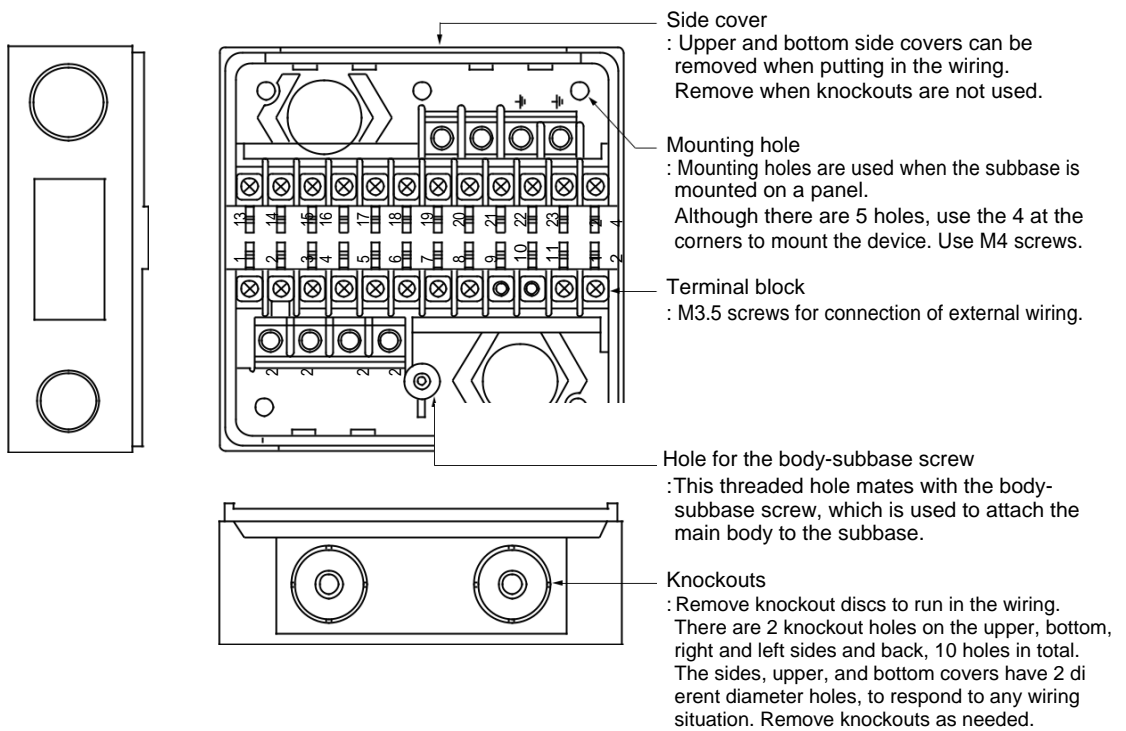

Note

- The shape and dimensions of the terminal block are shown below. Wiring will be easy if crimp type terminal lugs suitable for the dimensions written below.

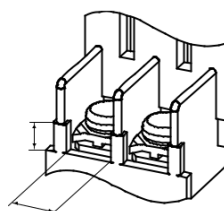



Chapter 1. OVERVIEW

„ Description of 7-segment display

⌘z Sequence code display

Normally, a code is displayed corresponding to the present stage of the operation sequence. The table below shows the displayed code and the concurrent stage in the sequence.

Display	Sequence	Description
--	Standby	Standby when the start contact input is off.
P1	Start check	Start check of this device and of the AUD300C.
P2	Ignition trial	Ignition of the pilot burner.
P3	Pilot Stabilization	Check to confirm reliable pilot burner ignition.
P4	Main Trial	Ignition of main burner.
P5	RUN	Flame monitoring after main burner ignition.
PL	Lockout	Lockout

⌘z Alarm code display

When lockout occurs, the display automatically changes to alarm code display, and the lockout sequence code and alarm code are alternately displayed.

Display	Alarm name	Description
E0	Start check alarm	The start check was not completed for some reason such as momentary power failure or part malfunction.
E1	Interlock alarm	Interlock occurred.
E2	False flame	A false flame such as a remaining flame was detected.
E3	UV alarm	A flame was detected even though the shutter output was off.
E4	Ignition failure	No flame was detected at the completion of the ignition trial.
E5	Flame failure	A flame failure occurred in the following sequence: <ul style="list-style-type: none">• Pilot Stabilization• Main Trial• RUN
EE	Other	When the cause of lockout cannot be identified: <ul style="list-style-type: none">• In cases where power was turned off before CPU error determination• In cases where vibration during transportation, etc., cause latch relay to switch to lockout

Handling Precautions

- If the DISP switch is pressed while an alarm code is displayed, the flame volt-age is displayed rather than the alarm code. When DISP is pressed again, the sequence code and the alarm code are alternately displayed.
- If the system is locked out and then reset, the display prior to lockout resumes. For example, if lockout occurs while flame voltage is displayed, the display changes to alarm display, in which the alarm code and sequence code are al-ternately displayed. After reset, flame voltage display resumes.



Flame voltage display

Flame voltage is displayed as 2 digits.

If the 7-segment display shows 3.2, it means 3.2 V.

Event display

When a pre-selected, preset event occurs, the orange EVENT LED lights up. If the DISP switch is pressed while EVENT is lit up, an event code from the table below is displayed. However, the event code is not displayed if lockout has occurred.

All active events can be cleared at the same time by pressing the DISP button for 2 s or longer.

Display	Event name	Description
A1	Ignition delay	ON when the ignition delay time exceeds the preset value.
A2	Shutter cycle count upper value (1 minute)	ON when the shutter cycle count exceeds the upper preset value.
A3	Shutter cycle count lower value (1 minute)	ON when the shutter cycle count drops below the lower preset value.
A4	Operation time for event	ON when the time since startup exceeds the preset value.
A5	Combustion time for event	ON when the RUN time exceeds the preset value.
A6	Combustion count for event	ON when the combustion count exceeds the preset value.
A7	Flame voltage upper value	ON when the flame voltage exceeds the preset value during RUN (display code: P5).
A8	Flame voltage lower value	ON when the flame voltage drops below the preset value during RUN (display code: P5).

Handling Precautions

- When the product is shipped, no event settings are configured. Therefore, it is necessary to configure event settings in order to have the EVENT LED light up and to have an event code displayed when an event occurs.

For details how to event setup, refer to;

 User's manual for Smart Loader Package Model SLP-A45 for Dynamic Self-Checking Burner Controller Model AUR450C (CP-SP-1187E).



Chapter 1. OVERVIEW

„ Terminal block signals

⌘z Subbase terminal block

The table below describes the terminals on the subbase.

Terminal No.	Description	Rated
1	Model AUD300C/500C terminal F (blue)	
2	Model AUD300C/500C terminal G (yellow)	
3	Unused	
4	Unused	
5	Unused	
6	Unused	
7	Model AUD300C/500C shutter (white)	24 V DC 150 mA
8	Model AUD300C/500C shutter (white)	
9	External reset input	
10		
11	Alarm output contact	75 VA max.
12		
13	Power supply (H)	100/120/200/230 V AC 50/60 Hz (depending on model No.)
14	Power supply (G)	
15	Start contact input	Contact resistance 100 Ω max.
16	Start contact input	
17	Interlock	100/120/200/230 V AC 50/60 Hz Contact resistance 100 Ω max.
18	Interlock	
19	Ignition transformer	300 VA max. (cos φ = 0.5)
20	Main valve	200 VA max. (cos φ = 0.5)
21	Intermittent pilot	200 VA max. (cos φ = 0.5)
22	Interrupted pilot	200 VA max. (cos φ = 0.5)
23	Flame monitor output	75 VA max. (cos φ = 0.5)
24	Flame monitor output	

⌘z Flame voltage terminals

The table below describes the flame voltage terminals on the front panel.

Terminal No.	Description	Rated
+	Flame voltage output (+)	0 to 5 V DC *
-	Flame voltage output (-)	

* The flame voltage may reach approx. 7 V during self-discharge.



Chapter 2. MOUNTING AND WIRING

2 - 1 Mounting

! WARNING



Before wiring, mounting, or removing this device, be sure to turn the power off. Wiring with the power on can result in an electric shock.

! CAUTION



Do not mount the AUR450C in the following places:

- In the presence of chemicals or corrosive gas, such as ammonia, sulfur, chlorine, ethylene compound, acid, or others.
- Where it is exposed to water drops or damp atmosphere.
- Where it is exposed to high temperatures.
- Where vibration continues for an extended period of time.



This device has a protective structure equivalent to IP20. Take measures to protect it from dust. In particular, if the equipment is designed to comply with CE/UL standards, be sure to mount this device in an instrument panel with IP54 or equivalent protection.



When installing or wiring, be sure to follow the instructions in this manual and in the manufacturer's manual for the combustion equipment.



If the wires from this device exceed the recommended length, to prevent malfunction due to external electrical noise, take measures such as keeping power lines away from the input lines between the control panel and the burner controller. After wiring, check that the equipment is operating properly.

„ Mounting locations

For effective heat radiation and convenient dismounting, wiring and maintenance, be sure to leave work space around the device as shown below.

Stand-alone mounting

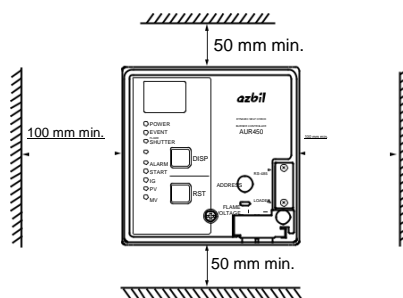

Close side-by-side mounting

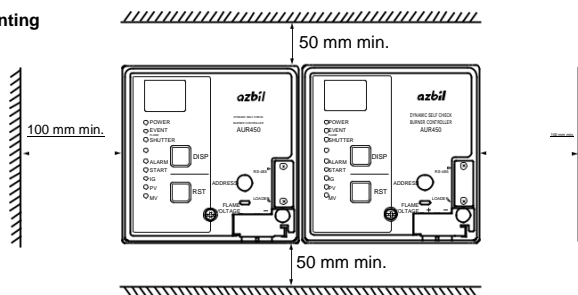

Handling Precautions

- When installing multiple devices, leave as much space as possible between the devices for heat dissipation.
- If ambient temperature is close to the allowable upper limit, use a panel cooler or cooling fan to reduce the panel box temperature.

Allowable ambient temperature upper limits:

Stand-alone mounting: 55 °C

Close side-by-side mounting: 45 °C



Chapter 2. MOUNTING AND WIRING

„ Mounting posture

Mount the controller so that the display/control panel is vertical, not horizontal, and its writing is correctly oriented.

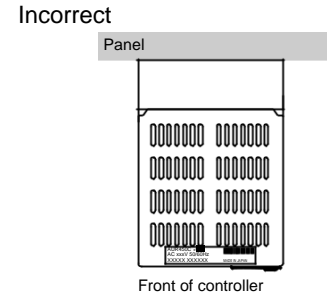
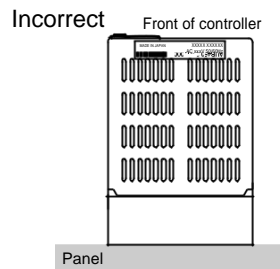
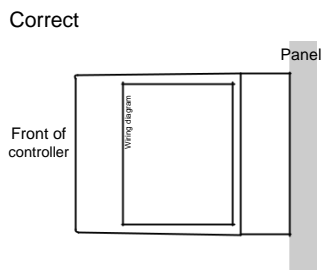
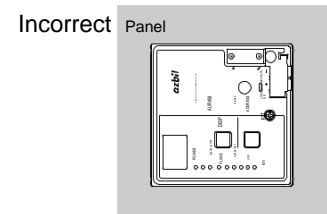
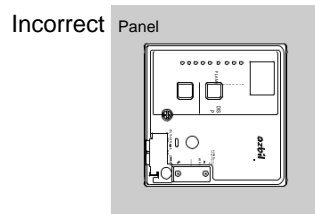
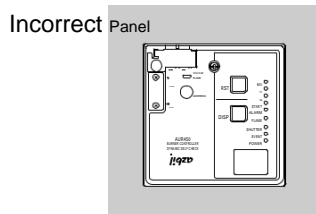
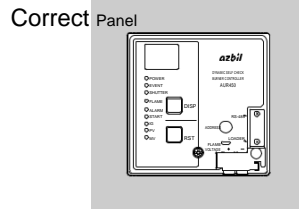

„ Mounting the subbase

Mount the subbase on a vertical surface. The threaded hole for the body-subbase screw should be in the lower portion of the vertically oriented subbase.

- (1) Open knockout holes on the subbase as required by the wiring situation.
- (2) Connect the wiring conduit(s).
- (3) Mount the subbase in the desired location with M4 screws, using the 4 mounting holes.

unit: mm

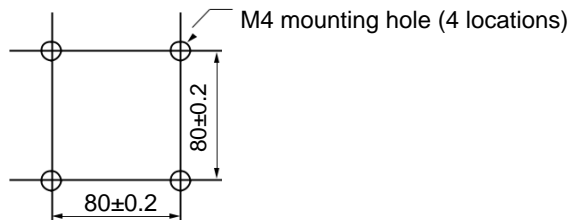

! Handling Precautions

- Although there are 5 holes, use the 4 holes at the corners, as shown in the above drawing.
- Tighten the screws with a torque of 1.5 N·m min. Failure to do so may break the subbase.

- (4) Connect the wiring in accordance with the description of Item 2-2 Wiring.



„ Mounting the controller

The method of mounting the controller on the subbase is described below.

- (1) With the controller positioned so that the main unit-subbase screw is near the bottom, latch the hook on top and then lower the controller so that it meets the subbase. Push the controller against the subbase so that the terminals make contact.



- (2) Tighten the main unit-subbase screw to secure the controller to the subbase. The maximum tightening torque of the screw is 0.5 N m.

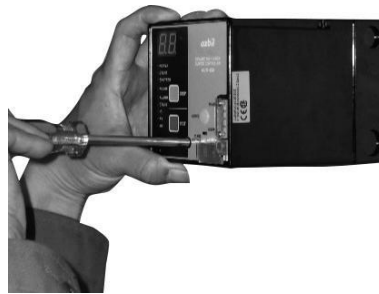

- (3) Attach the code label to the panel or some other easy-to-see location near the controller so that when an alarm occurs, it will be easily identifiable.

AUR450 7セグメント表示 / 7-segment display					
シーケンスコード Sequence code		アラームコード Alarm code		イベントコード [*] Event code	
表示 Display	内容 Description	表示 Display	内容 Description	表示 Display	内容 Description
—	待機 Standby	E0	スタートチェック異常 Start check alarm	A1	着火遅れ Ignition delay
P1	スタートチェック Start check	E1	インターロック異常 Interlock alarm	A2	シャッター動作異常上取 Shutter operation abnormality
P2	(パイロット用) 17% Ignition trial	E2	疑似火災 False flame	A3	シャッター動作異常下取 Shutter operation abnormality
P3	パイロットオンリー Pilot only	E3	UV異常 UV alarm	A4	イベント応答時間 Operation time for event
P4	メイントライアル Main trial	E4	不着火 Ignition failure	A5	イベント応答時間 Comparison time for event
P5	空燃機 RUN	E5	断火 Flame failure	A6	イベント応答回数 Combustion count for event
				A7	フレーム感圧上取 Frame release upper safety
				A8	フレーム感圧下取 Frame release lower safety

^{*} イベントコードはEVENT LED点灯時にDISPスイッチを押しすることにより表示します。
An event code is displayed if the DISP switch is pressed while EVENT is lit up.

„ Dismounting the controller

Remove the main unit-subbase screw first, and then, while holding the subbase, lift off the controller, bottom first.



















Chapter 2. MOUNTING AND WIRING

2 - 2 Wiring

WARNING

-  Connect loads (ignition transformer, solenoid valve, etc.) directly to the output terminals of this device. Otherwise, combustion safety cannot be ensured.
When using an auxiliary relay due to lack of contact capacity, etc., take protective measures in case a relay malfunction or contact welding occurs.
-  Do not extend the lead wires of the reset input for more than the allowable length of 10 meters. Always input the reset command from beside the combustion equipment, not from a remote location. Because a safety check cannot be made far from the equipment, there is an increased risk of explosion.
-  Before wiring, mounting, or removing this device, be sure to turn the power off. Wiring with the power on can result in an electric shock.

CAUTION

-  Installation, wiring, inspection, adjustment, etc. should be carried out by a trained and experienced technician who has knowledge and technical skills related to combustion equipment and flame safeguard control devices.
-  Make sure the load connected to each terminal does not exceed the rating indicated in the specifications.
-  If timers and auxiliary relays are needed for additional functions, select ones with high reliability, and be sure to design the circuit correctly.
-  When installing and wiring, be sure to follow the instructions in this manual and in the user's manual for the combustion equipment.
-  Run the high-voltage ignition transformer cable separately and keep it at least 10 cm away from this device.
-  Keep power lines and ignition transformer high-voltage cables separate from the AUD300C/500C cables and from the external reset input cable.
-  Make sure that ignition transformer high-voltage cables are properly connected to prevent faulty contact. Faulty contact might generate highfrequency radio waves which can cause malfunction.
-  Always connect the power supply last. Otherwise, touching a terminal accidentally could result in electric shock or damage.
-  Always supply electric power at the voltage and frequency stated on the model label of this device.
-  In keeping with technical standards for electrical equipment, the burner body must have an earth ground connection with a resistance of less than 100 Ω.
-  After the wiring is complete, be sure to check that it is correct. Incorrect wiring may cause damage or faulty operation.
-  Do not short the control load terminals (18-19, 18-20, 18-21, or 18-22) or the shutter terminals (7-8). Internal fuses between these terminals will burn out if these terminals are shorted.
If a fuse burns out, replace the entire product.



⚠ CAUTION

⊘ Do not configure a circuit that turns off the interlock input (terminals 17-18) using the alarm output contacts (terminals 11-12). With such a circuit, if a false flame, UV alarm, ignition failure, or flame failure occurs, the interlock alarm may be displayed.

❗ Firmly tighten the terminal screws to the torque listed in the specifications.

❗ If there is a risk of a power surge caused by lightning, use a surge absorber (surge protector).

❗ If there is an inverter or the like that generates strong electrical noise near this device, take noise-suppression measures, referring to the user's manual for the noise-generating equipment.

„ Wiring diagram

⚠ WARNING

⊘ Never short-circuit the start contact in order to start and stop this device by switching the power on and off. This is very important for reliable activation of the self-check circuit at device startup. Failure to observe this warning could lead to an explosion.

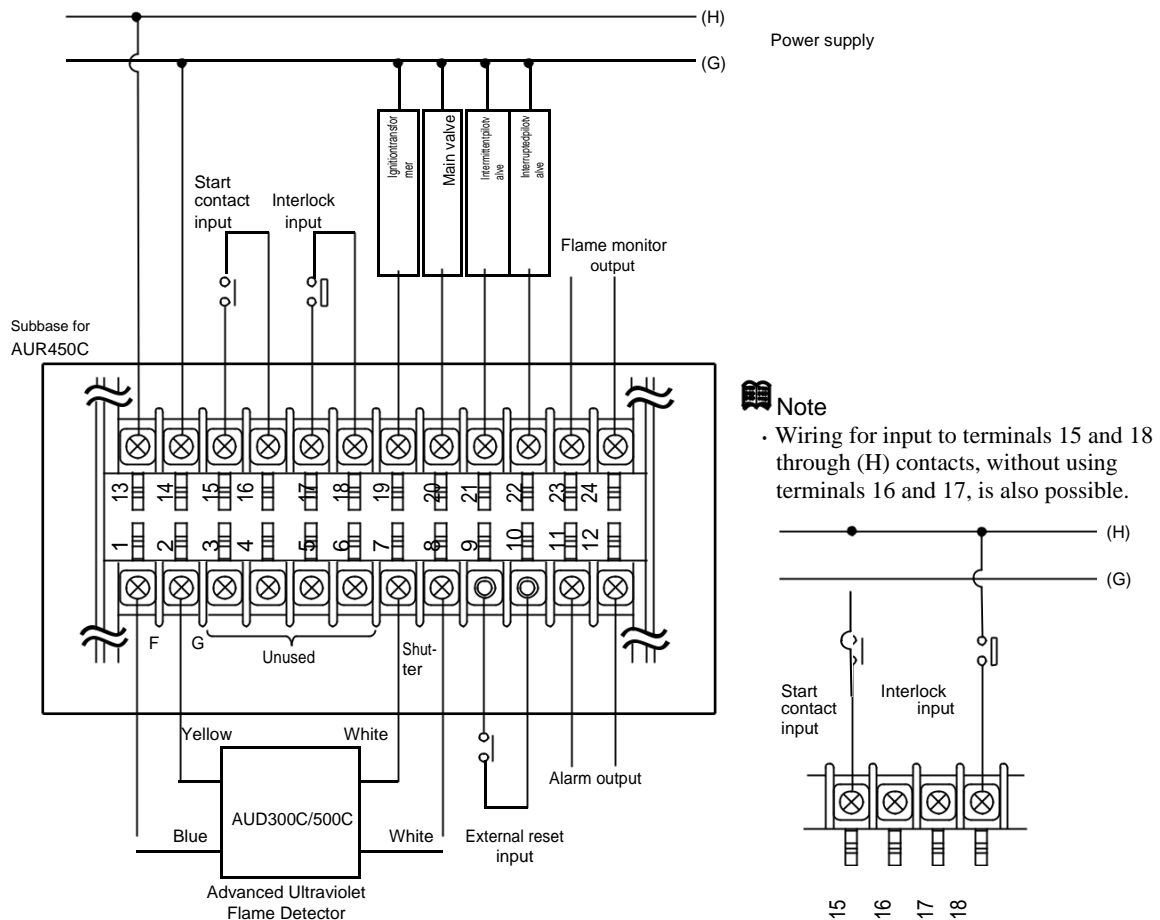

❗ Handling Precautions

- If the power source has a voltage side (H) and a ground side (G), connect the voltage side (H) to terminal 13 and the ground side (G) to terminal 14.



Chapter 2. MOUNTING AND WIRING

- Do not use unused terminals as relay terminals.
- Use an overload prevention device for the power supply as needed.
- For wiring to the power source, use a 0.75 mm² wire (30 cores, 0.18 mm dia.) in keeping with JIS C3306.
- Terminal screws for the external reset input (terminal numbers 9 and 10) are not assembled. When using the external reset input, wire to the subbase using the included terminal screws.
- For the external reset input signal and flame voltage output signal, use IV wire 0.75 mm² in cross-sectional area. Wire length should be 10 m max.
- Be sure to set up a separate external reset input for each device. The external reset input of another device cannot be shared.
- Although terminals with a ground mark are provided on the subbase, this de-vice is not grounded.

※ Connecting to a surge absorber

When using the optional surge absorber as a protective measure against lightning, connect it as shown below.

Model No.: 83968019-001 (sold separately)

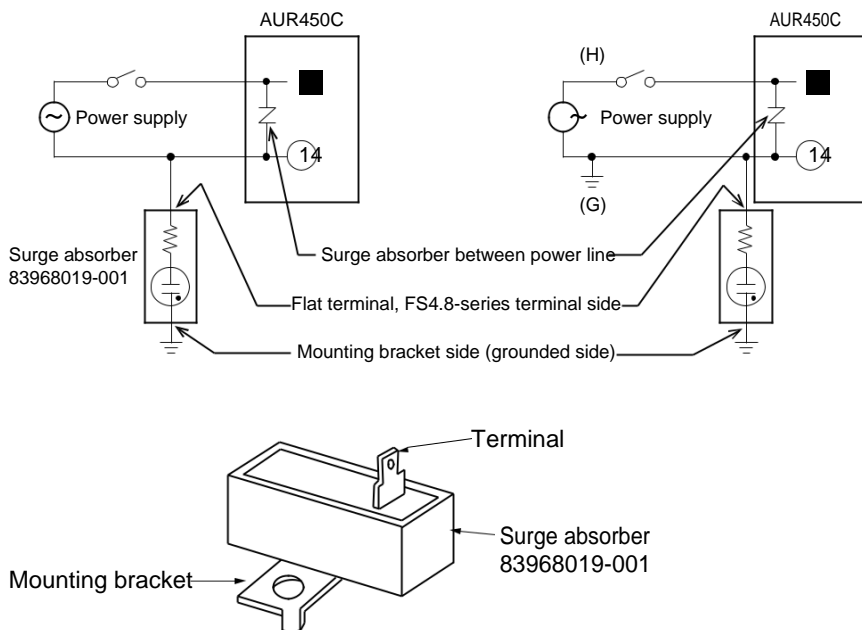

! Handling Precautions

- Connect an FS4.8 series flat connector (AMP's #187 series receptacle or equivalent) to one end of the electric cable, keeping the wiring as short as possible.
- Connect Mounting bracket of the surge absorber 83968019-001 to the metal part such as the burner grounded.



„ Connection to the Model AUD300C/500C

Wire the AUD300C/500C as shown below.

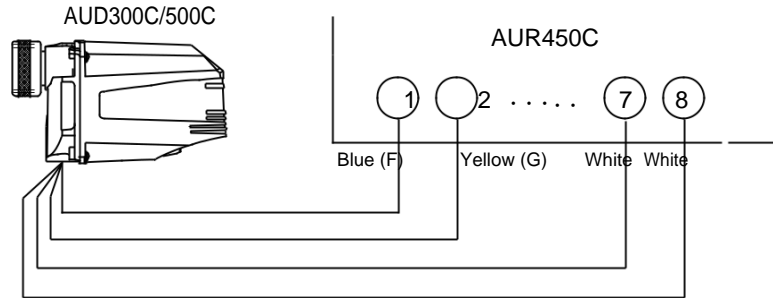

! Handling Precautions

- The signal wires of the AUD300C/500C (blue and yellow) have specific polarities. Connect the blue wire to terminal 1 (F) of the device and the yellow wire to terminal 2 (G). Reversing the signal wires may cause the tube unit to break or malfunction.
- To extend the wiring, use 2 mm² 600 V-vinyl insulated IV cable with a length of 200 m or less.

„ Checking the connection between the controller and the Model AUD300C/500C

Required equipment: Tester

Input impedance: 100 kΩ min.

To check if the connection to the controller is correct, remove the tube unit of the AUD300C/500C and measure the DC voltage between terminals F and G with the tester as shown below.

Connect the + tester probe (red) to terminal G (yellow lead wire) and the – tester probe (black) to terminal F (blue lead wire).

If the reading is between 160 and 220 V DC, the leads are connected correctly.

If there is a minus reading for the DC voltage, the leads to terminals F and G are reversed.

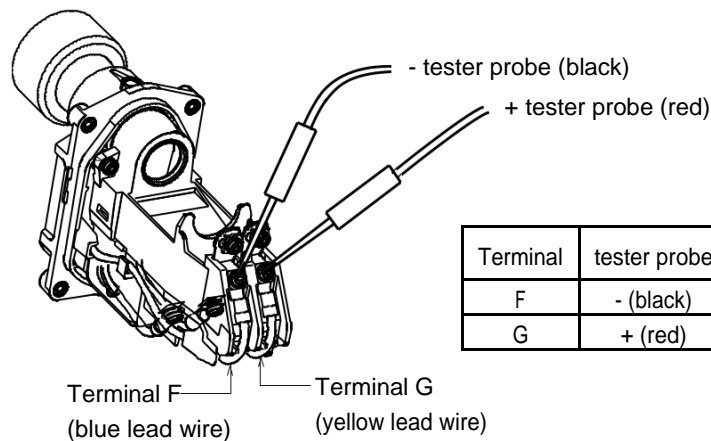

Terminal	tester probe	Voltage
F	- (black)	160 to 220 V DC
G	+ (red)	



Chapter 2. MOUNTING AND WIRING

„ Wiring to a solenoid valve

WARNING



Do not connect a solenoid valve to the high voltage side of the circuit. If a ground fault occurs, the ground fault current may energize and open the solenoid valve. This device will not be able to prevent the valve from opening and fuel from flowing out.

⌘z Correct connection

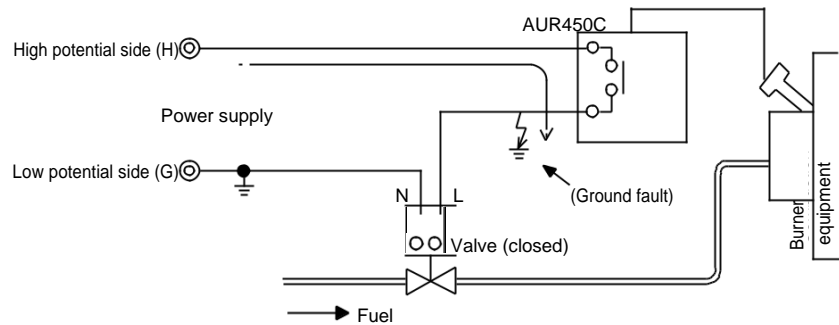

When the valve wiring is connected correctly as shown in the figure above, current does not flow through the solenoid valve even if a ground fault occurs due to faulty insulation on the high voltage side (H). Therefore, the valve does not open and fuel does not flow out.

⌘z Incorrect connection

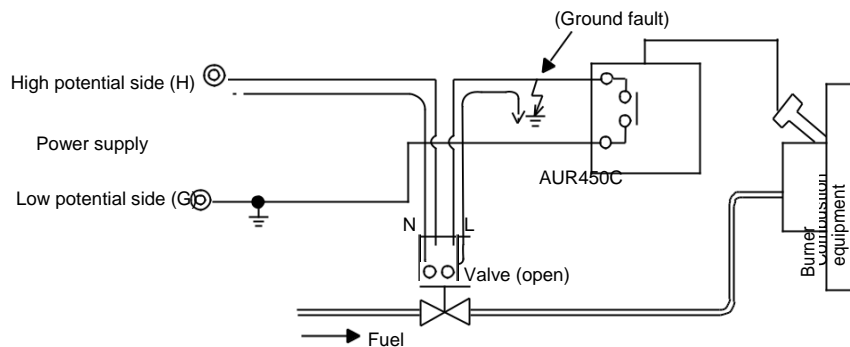

If the valve wiring is connected to the high voltage side, current flows through the solenoid valve if a ground fault occurs, as shown in the figure above. Therefore, the valve opens in spite of the device and fuel flows out.



„ Wiring for continuous measurement of flame voltage

To measure the flame voltage, remove the cover from the flame voltage terminal and connect a signal wire to it.

! Handling Precautions

- Always use an IV cable with a size of 0.75 mm² or more for signal lines. The wiring length must be 10 m or less.
- Connect a measuring instrument to the device having an input impedance of 100 kΩ or more and connect a pen recorder having an input impedance of 1 MΩ or more.

⌘ Removing the terminal cover

■ Handling Precautions

- Do not remove the cover with your fingers. The cover may break.

Required tool: a screwdriver

- (1) Insert the screwdriver between the terminal cover and terminal.



- (2) Gently raise the grip of the screwdriver.

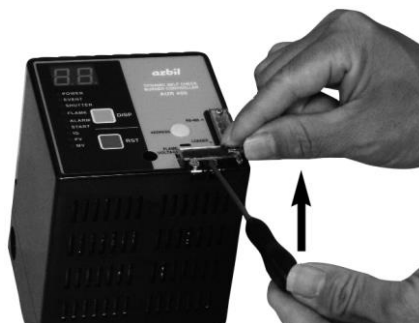

The terminal cover will come off easily.





Chapter 2. MOUNTING AND WIRING

⌘z Mounting the terminal cover

When wiring is done, reattach the flame voltage terminal cover.

- (1) Insert the left part of the cover into the square hole on the controller.



- (2) Push the right side of the cover into place by hand.





2 - 3 Communications Connections

„ Smart Loader connection

To use the Smart Loader Package (hereafter SLP), remove the terminal cover (the same one used for the flame voltage terminal) and connect the dedicated cable from the loader jack to a PC.

☞ Removing the terminal cover (P. 2-9).

Note

- For details operations of SLP, refer to;
 - ☞ User's manual for Smart Loader Package Model SLP-A45 for Dynamic Self-Checking Burner Controller Model AUR450C (No. CP-SP- 1187E).

„ Connection of RS-485 communications

For RS-485 communications, remove the cover from the RS-485 communications connector and attach a compatible connector
The controller uses 3-wire RS-485 communications.

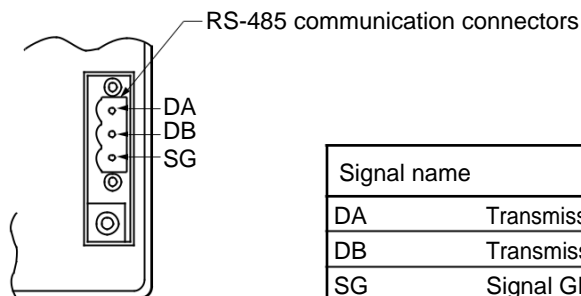

Signal name	Description
DA	Transmission and reception terminal +
DB	Transmission and reception terminal -
SG	Signal GND terminal

Compatible connectors : Phoenix Contact model No.: MSTB2.5/3-STF-5.08
Azbil Corporation model No.: 81446848-001 (1 connector)

! Handling Precautions

- Use shielded twisted pair cable for RS-485 communication wiring.

⌘ Communication setting

Station address is set by the ADDRESS switch.

Data format and transmission speed can be set as shown in the table below using the loader (in this case, settings are effective after turning the power off and back on again).

Item	Description	Initial value
Data format	Data length 8 bit, even parity, stop bit 1 bit / Data length 8 bit, no parity, stop bit 2 bits	Data length 8 bit, even parity, stop bit 1 bit
Transmission speed	19200/9600/4800/2400 bps	19200 bps



Chapter 2. MOUNTING AND WIRING

„ Connection to a 3-wire system

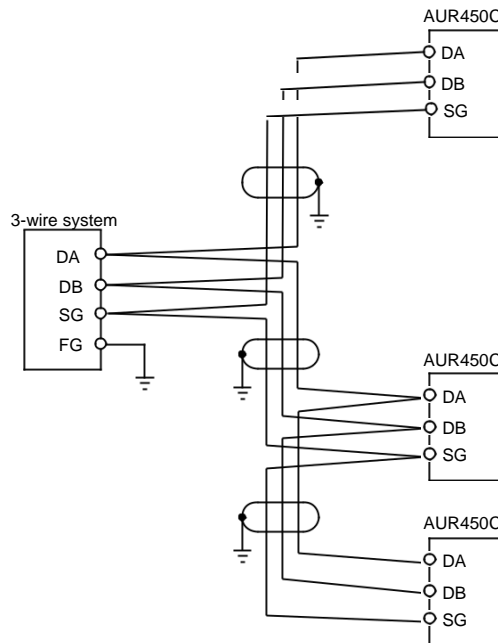

„ Connection to a 5-wire system

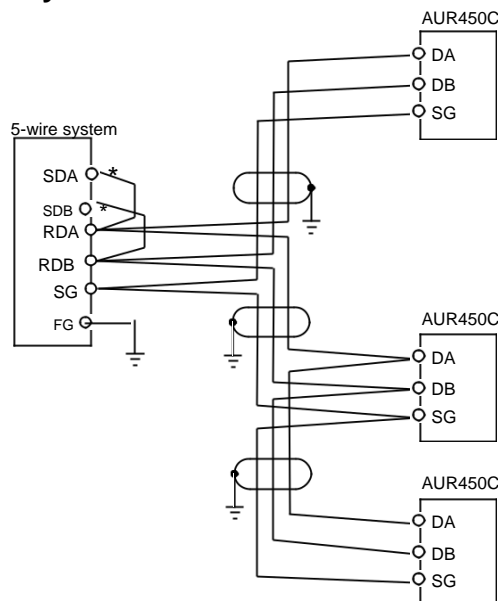

IMPORTANT Terminating resistor

- Do not connect any terminating resistor to either end of the communication path. Doing so might cause a communications failure.
- Even if there are devices requiring a terminating resistor in the communication path, do not connect a terminating resistor.



บริษัท เอดีดี เฟอร์เนส จำกัด

ADD FURNACE CO.,LTD.

44 ซอยบรมราชชนนี 70 ถนนบรมราชชนนี แขวงศาลาธรรมสพน์ เขตทวีวัฒนา กรุงเทพฯ 10170

โทร: 02-888-3472 โทร.) ออกแบบ:(08-08-170-170 แฟกซ์: 02-888-3258

<https://www.add-furnace.com> E-mail: sales@add-furnace.com



Handling Precautions

- Use a twisted shielded pair cable for RS-485 communications.
- Ground shielded wire to one point on one side of the cable.
- When a 5-wire system is used, wire the connections marked with an asterisk (*) externally.



Chapter 3. OPERATION

„ Example of instrumentation for the Model AUR450C with an interrupted pilot

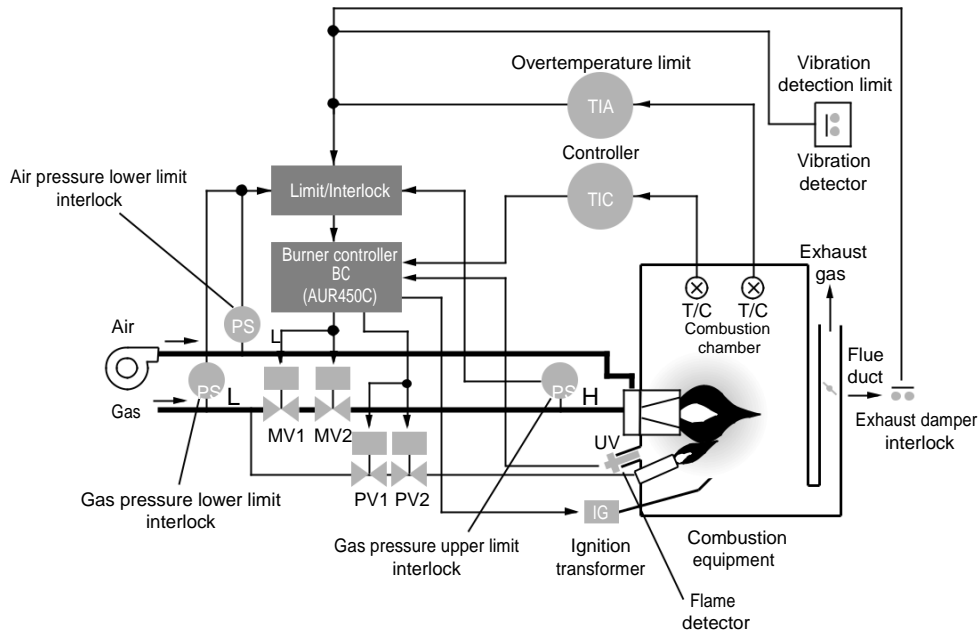

„ Precautions for instrumentation and circuit configuration with an interrupted pilot

In instrumentation and circuit configuration of the device with an interrupted pilot valve, note the following:

- For safety control and operation circuits, devise a safety plan based on risk assessment.
- Configure the interlock (including limit) contacts so as to directly disconnect loads (ignition transformer, pilot safety shutoff valve, main safety shutoff valve, etc.).
- Design a circuit that shuts down all the burners when a ignition failure or a flame failure of the pilot or main burner occurs.
- Install all the interrupt contacts on the high potential (non-ground) side of the power supply.
- As needed, take preventive measures against electrical leakage, such as using an electrical leakage breaker or a double pole contact system.
- Do not configure a circuit that turns off the interlock input (terminals 17-18) using the alarm output contacts (terminals 11-12). With such a circuit, if a false flame, UV alarm, ignition failure, or flame failure occurs, the interlock alarm may be displayed.



Chapter 3. OPERATION

„ Internal block diagram

The internal block diagram below shows an example of wiring with external devices.

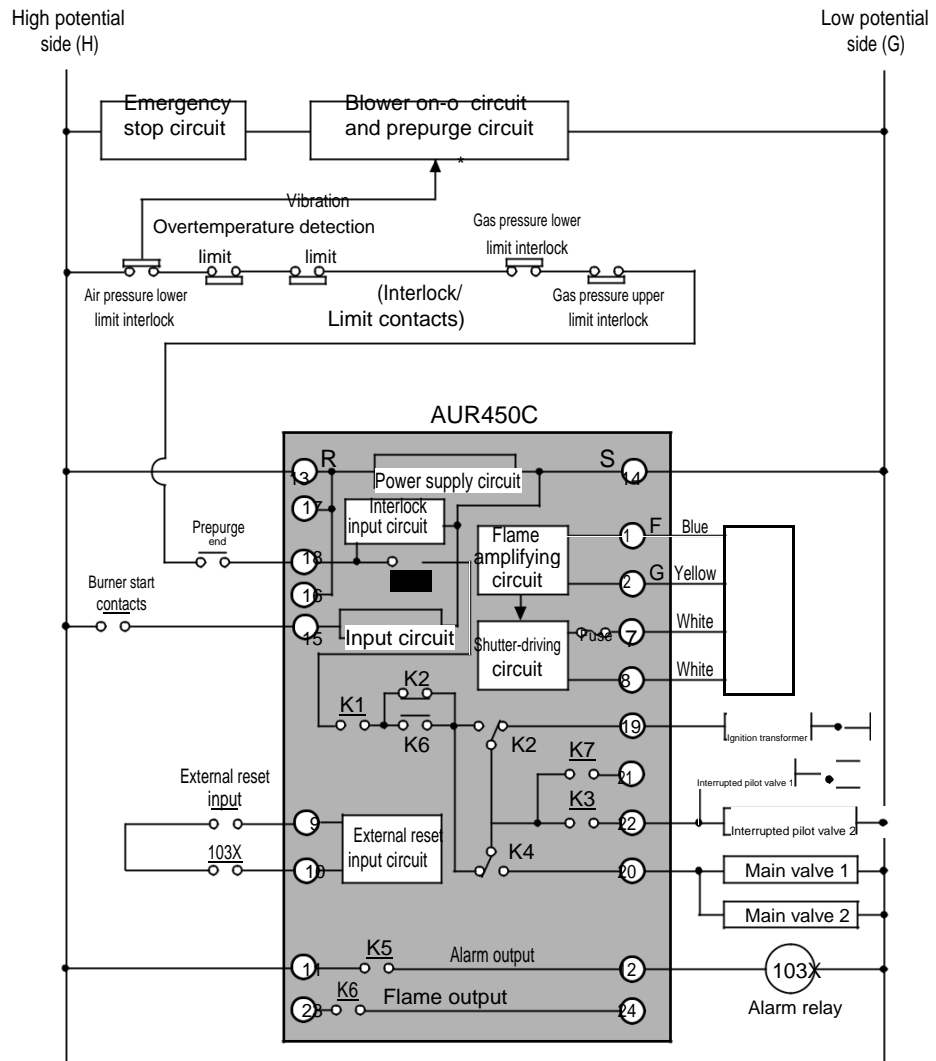

- * Air pressure switch
 Configure a verification circuit that does the following:
- When the blower is about to start, and there is no air flow, the circuit should verify that no pressure is detected. If pressure is detected under these conditions, the blower should not be started.

Note

- JIS B8415 defines ignition times as follows.
 Pilot burner ignition time: within 10 s.
 Main burner ignition time: within 5 s.



„ Sequence charts

Operation sequences for this device are shown below.

! Handling Precautions

- Sequence charts include the following operations. When the blower on-off circuit and prepurge circuit completes the prepurge, the prepurge completion contacts connected to terminal 18 of the AUR450C are turned ON, the burner start contacts are turned ON, and burner operation proceeds.

⌘ Normal operation

When the start contact is turned ON, with the power supply and interlock also ON, the operation progresses to RUN following the sequence shown below. When the start contact is turned OFF, the sequence goes to standby.

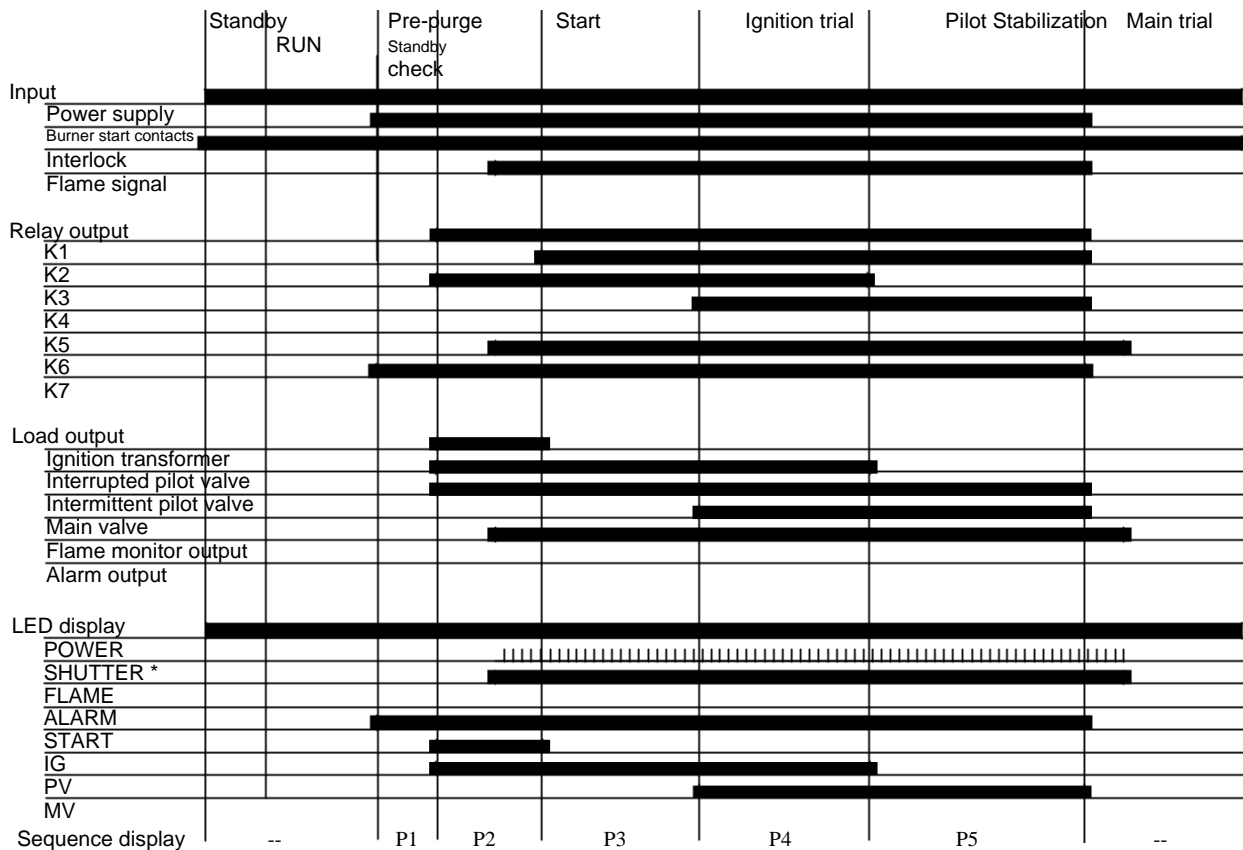

* When the voltage output to the shutter is ON (opening), the shutter LED goes off. When the voltage output to the shutter is OFF (closing), the shutter LED lights up.



Chapter 3. OPERATION

##z Start check error due to false flame

If an error (false flame) is detected during the start check and normal operation does not resume for 10 seconds, the system is locked out. While the false flame is detected, the K6 flame monitor output is ON.

On the device, E2 (false flame) and P1 are displayed alternately.

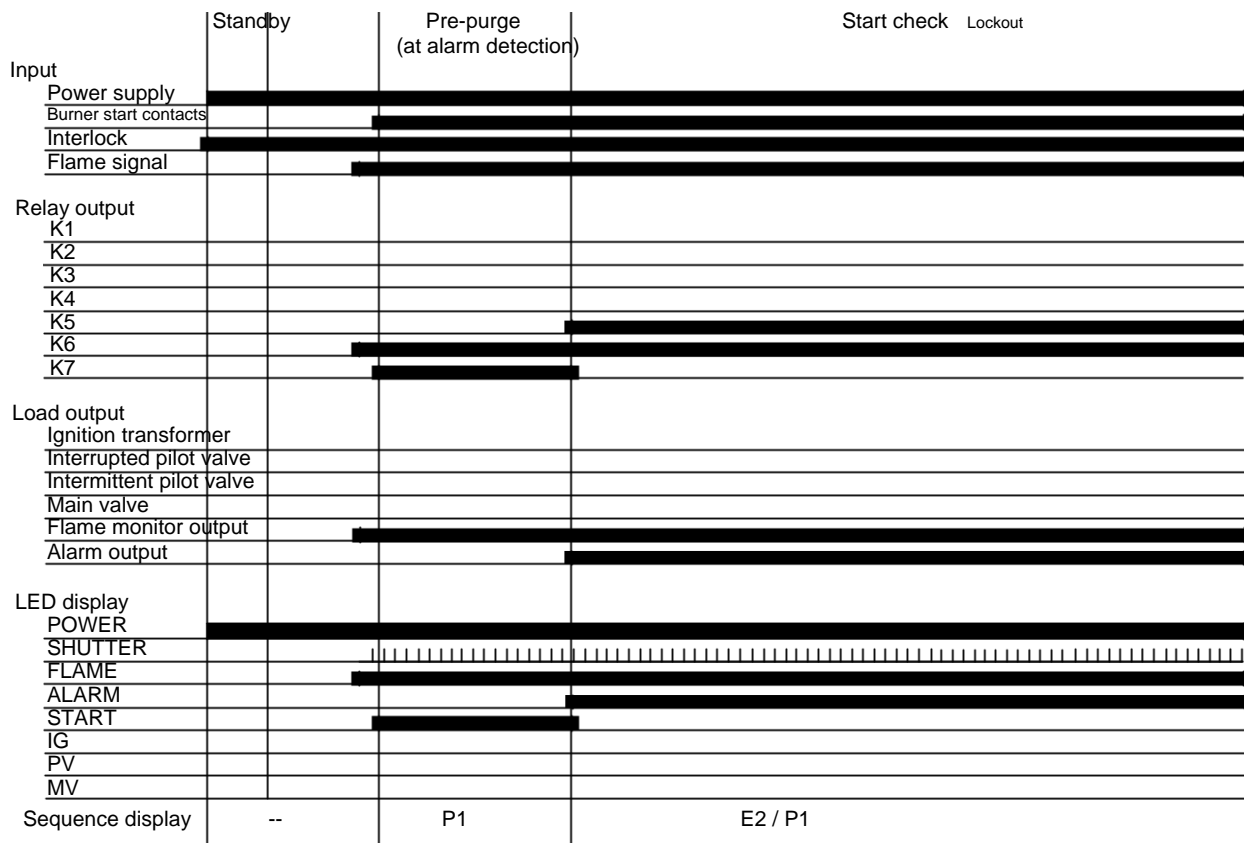



⌘z Start check error due to self-discharge

If an error (self-discharge) is detected during the start check and normal operation does not resume for 10 seconds, the system is locked out. In this case, there is no flame monitor output and the FLAME LED does not light up. On the device, E3 (UV alarm) and P1 are displayed alternately.

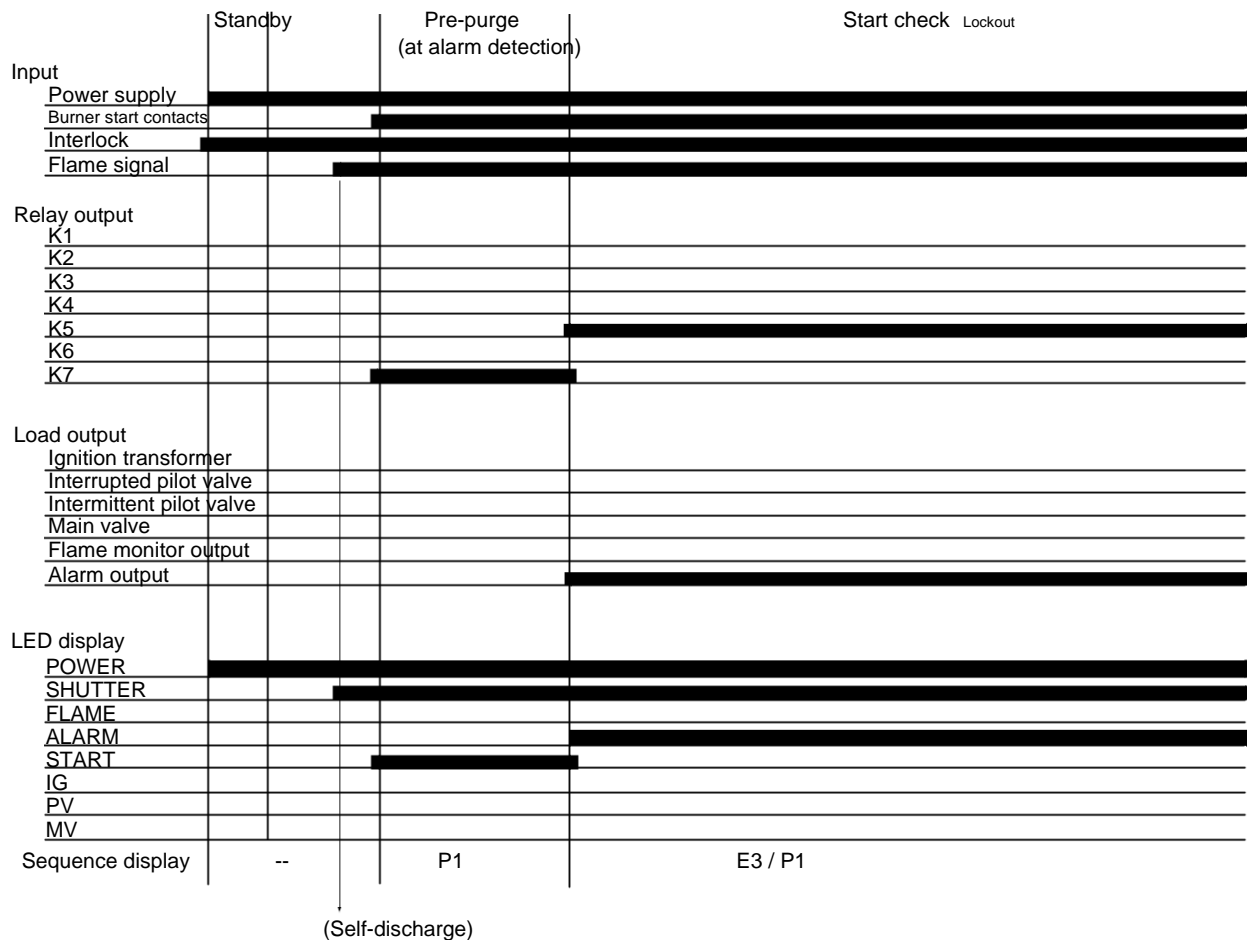



บริษัท เอดีดี เฟอร์เนส จำกัด

ADD FURNACE CO.,LTD.

44 ซอยบรมราชชนนี 70 ถนนบรมราชชนนี แขวงศาลาธรรมสพน์ เขตทวีวัฒนา กรุงเทพฯ 10170

โทร: 02-888-3472 โทร.) ออกแบบ:(08-08-170-170 แฟกซ์: 02-888-3258

https://www.add-furnace.com E-mail: sales@add-furnace.com

Chapter 3. OPERATION

⚠ Ignition failure

If ignition is not detected after the ignition trial time period, the system is locked out and an alarm is output.

On the device, E4 (ignition failure) and P2 are displayed alternately.

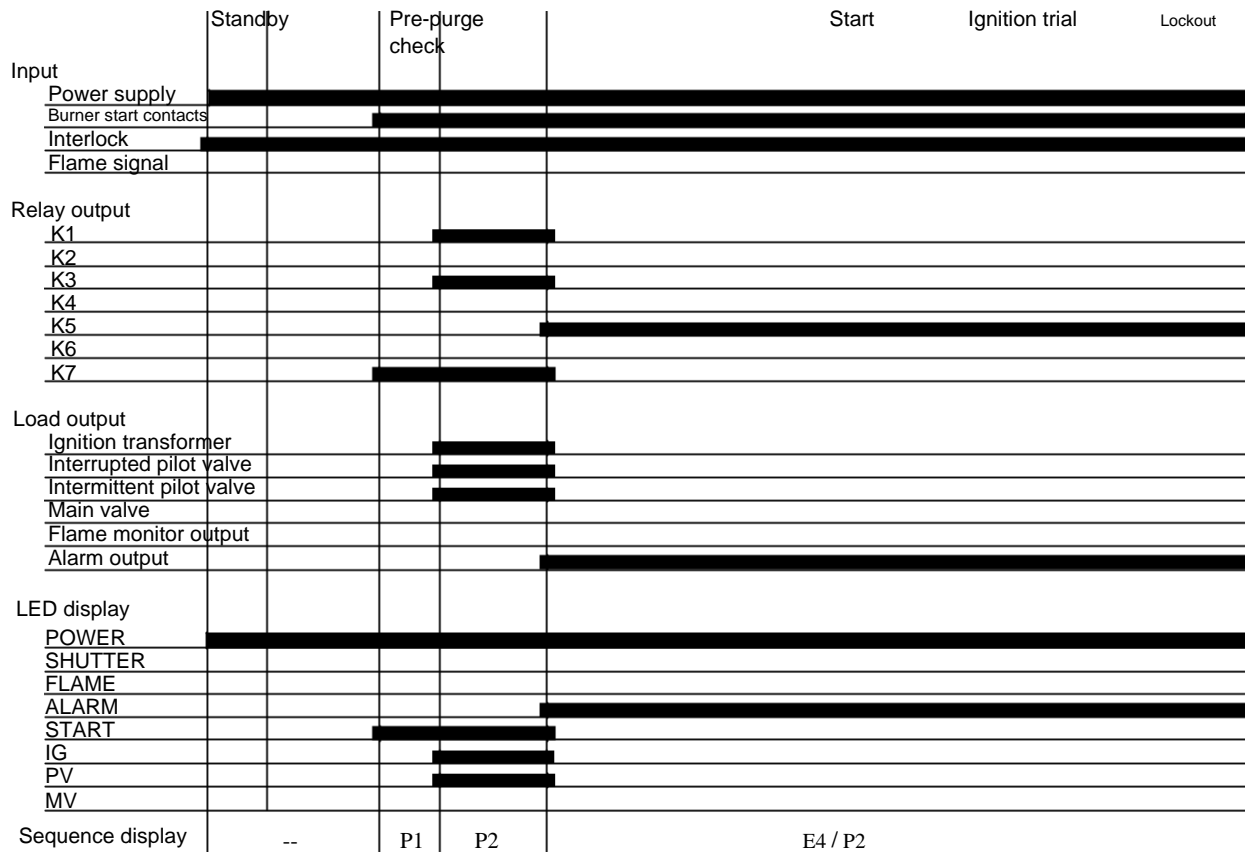



Flame failure

If a flame failure is detected during Run, the system is locked out and an alarm is output.

On the device, E5 (flame failure) and P5 are displayed alternately.

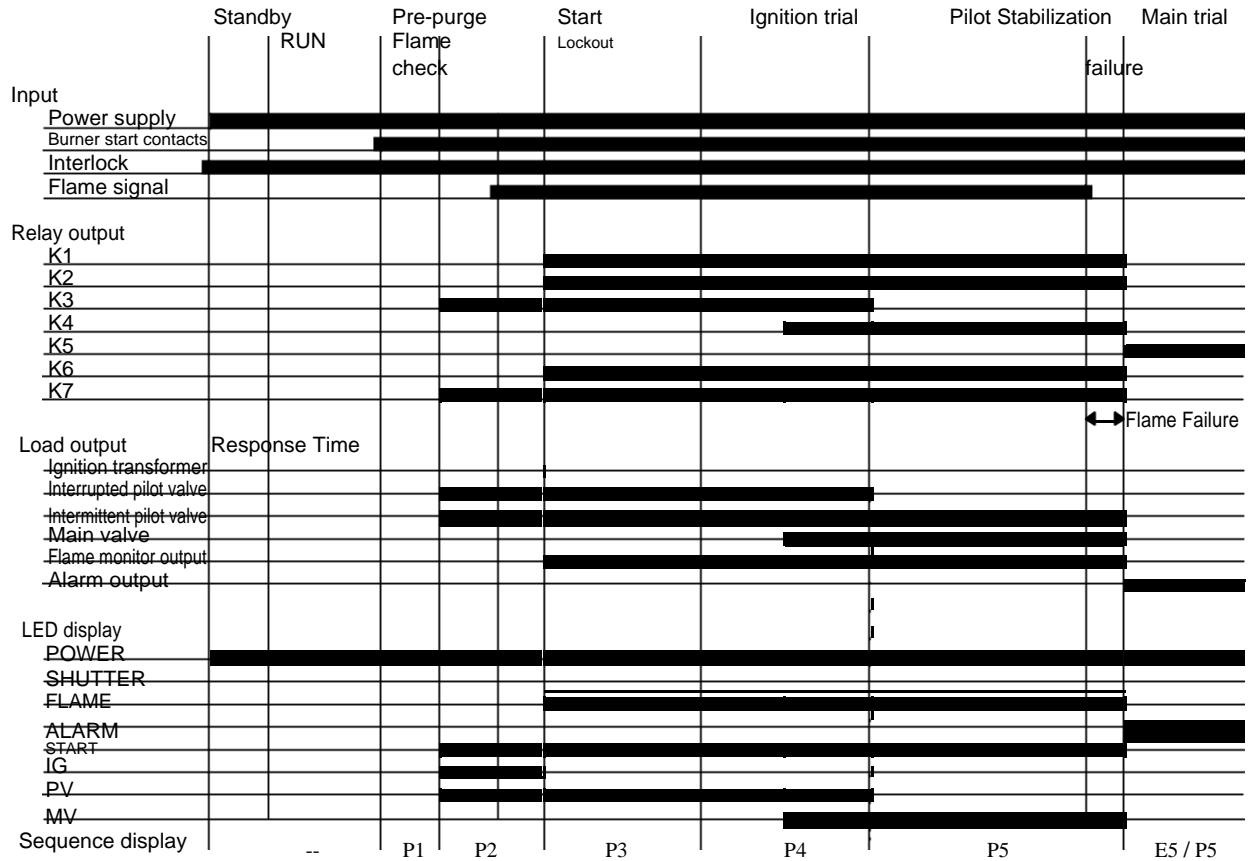



Chapter 3. OPERATION

Interlock during Run-state

If the interlock contact is disconnected or changed to OFF, the system is locked out and an alarm is output.

On the device, E1 (interlock) and P5 are displayed alternately.

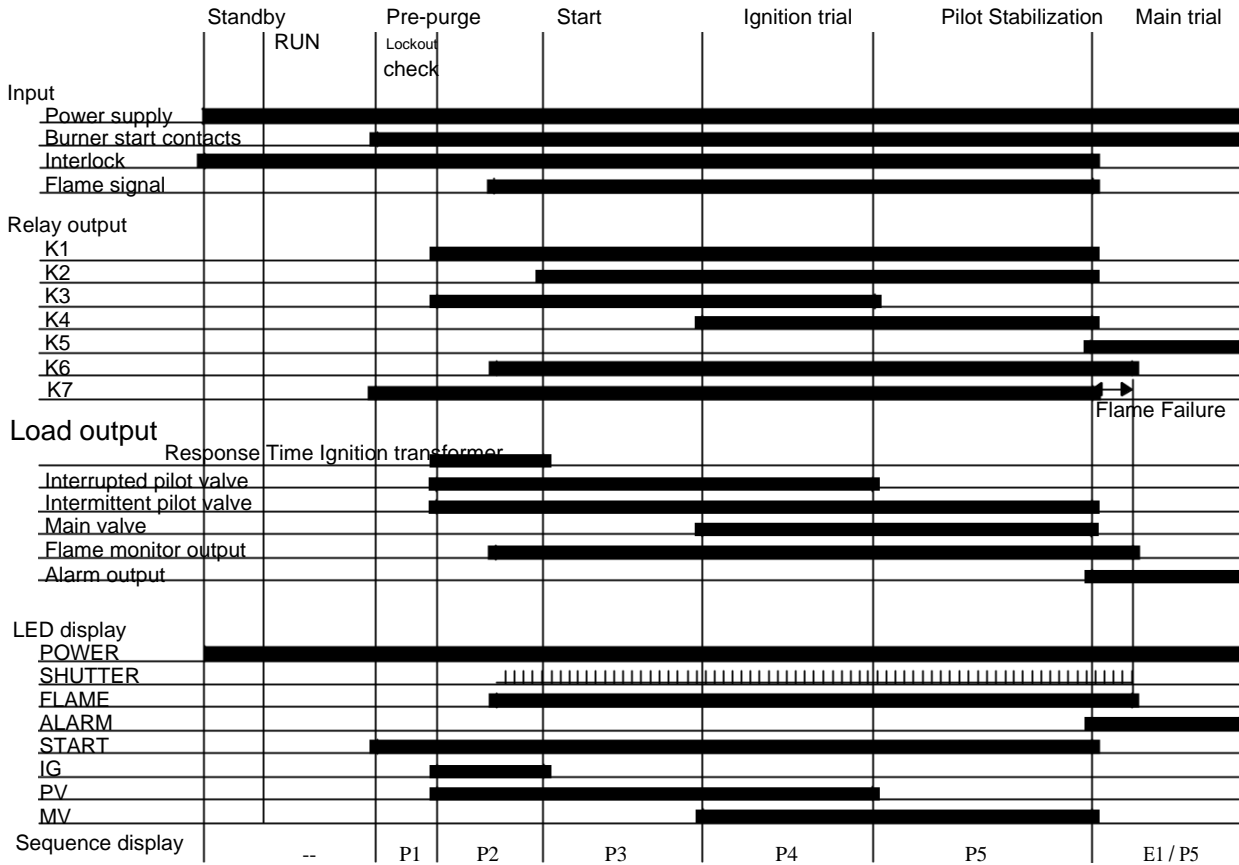



Chapter 3. OPERATION

⚠ Interlock during stand-by state

The system is not locked out though the interlock contact is disconnected or changed to OFF during standby, and then a start signal is input, the system is locked out and an alarm is output.

On the device, E1 (interlock) and P1 are displayed alternately.

	Standby	Pre-purge	Lockout
Input			
Power supply	Active	Active	Active
Burner start contacts	Active	Active	Active
Interlock	Active	Active	Active
Flame signal	Active	Active	Active
Relay output			
K1	Active	Active	Active
K2	Active	Active	Active
K3	Active	Active	Active
K4	Active	Active	Active
K5	Active	Active	Active
K6	Active	Active	Active
K7	Active	Active	Active
Load output			
Ignition transformer	Active	Active	Active
Interrupted pilot valve	Active	Active	Active
Intermittent pilot valve	Active	Active	Active
Main valve	Active	Active	Active
Flame monitor output	Active	Active	Active
Alarm output	Active	Active	Active
LED display			
POWER	Active	Active	Active
SHUTTER	Active	Active	Active
FLAME	Active	Active	Active
ALARM	Active	Active	Active
START	Active	Active	Active
IG	Active	Active	Active
PV	Active	Active	Active
MV	Active	Active	Active
Sequence display	--	E1 / P1	



Chapter 3. OPERATION

„ Example of instrumentation for the Model AUR450C with an intermittent pilot

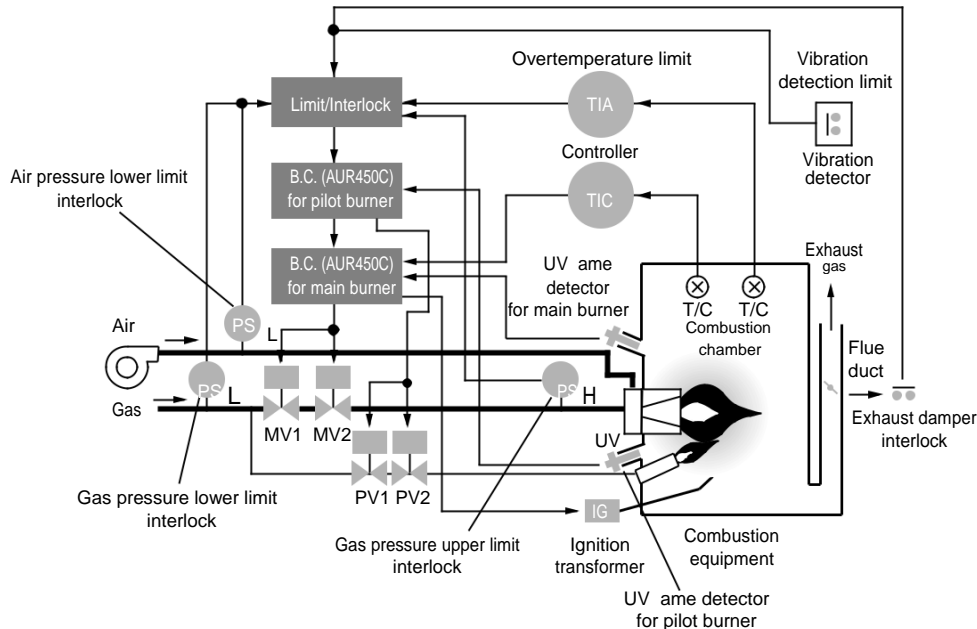

„ Precautions for instrumentation and circuit configuration with an intermittent pilot

A fundamental rule for intermittent pilots is that a separate monitoring system is required for the pilot and main burners.

In instrumentation and circuit configuration of the device with an intermittent pilot valve, note the following:

- For safety control and operation circuits, devise a safety plan based on risk assessment.
- Install separate combustion monitoring equipment (flame detector and burner controller) for the main burner and pilot burner.
- Install the flame detector for the main burner in a location where it does not detect the pilot burner flame.
- Be sure to connect the limit contacts and interlock contacts to the interlock input terminals of the burner controllers for both the pilot and main burners in such a way that the circuit can directly disconnect loads (ignition transformer, pilot safety shutoff valves, main safety shutoff valves, etc.).
- When configuring the start circuit, be sure to connect the pilot ignition signal output from the burner controller for the pilot burner to the interlock input terminal and start input terminal on the burner controller for the main burner.
- Design a circuit that shuts down all the burners when a ignition failure or a flame failure of the pilot or main burner occurs.
- Install all the interrupt contacts on the high potential (non-ground) side of the power supply. As needed, take preventive measures against electrical leakage, such as using an electrical leakage breaker or a double pole contact system.
- Do not configure a circuit that turns off the interlock input (terminals 17–18) using the alarm output contacts (terminals 11–12). With such a circuit, if a false flame, UV alarm, ignition failure, or flame failure occurs, the interlock alarm may be displayed.



„ Internal block diagram

The internal block diagram below shows an example of wiring with external devices.

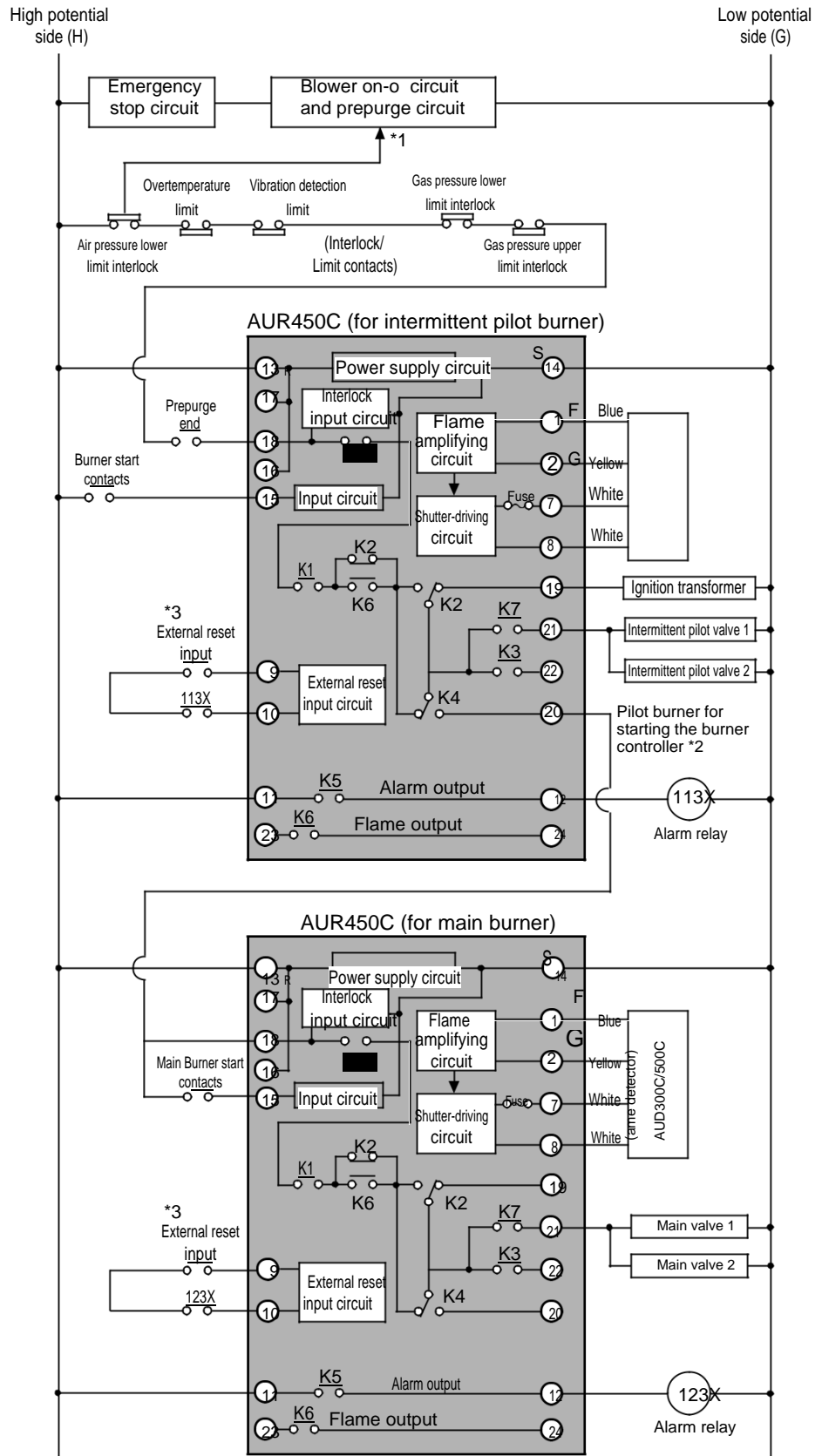



บริษัท เอดีดี เฟอร์เนส จำกัด

ADD FURNACE CO.,LTD.

44 ซอยบรมราชชนนี 70 ถนนบรมราชชนนี แขวงศาลาธรรมสพน์ เขตทวีวัฒนา กรุงเทพฯ 10170

โทร: 02-888-3472 โทร.) ออกแบบ:(08-08-170-170 แฟกซ์: 02-888-3258

<https://www.add-furnace.com> E-mail: sales@add-furnace.com

Chapter 3. OPERATION

- *1. Air pressure switch
Configure a verification circuit that does the following:
When the blower is about to start, and there is no air flow, the circuit should verify that no pressure is detected. If pressure is detected under these conditions, the blower should not be started.
- *2. When configuring the circuit, use the pilot ignition signal output as the condition for starting the burner controller for the main burner and for activating the interlock.
- *3. Be sure to set up a separate external reset input for each AUR450C. The external reset input of another AUR450C cannot be shared.





Note

- JIS B8415 defines ignition times as follows.
Pilot burner ignition time: within 10 s.
Main burner ignition time: within 5 s.





Chapter 4. TRIAL-RUN ADJUSTMENT

WARNING

-  Do not allow the pilot or main burner “Safety time” (ignition trial time) to exceed the specifications of the burner or equipment manufacturer. If they do, fuel may accumulate in the combustion chamber and form an explosive airfuel mixture, resulting in a serious explosion hazard.
-  Terminals and the connected flame detector signal cable retain an electrical charge even after the power is turned OFF. To avoid electric shock, do not touch terminals F and G or the cable immediately after power-off.
-  Do not start regular operation of the equipment without first completing the trial-run adjustments for this device, as well as the tests specified by the equipment manufacturer.
-  If lockout occurs, be sure to do a prepurge before restarting the system. If the combustion chamber and gas flue are not ventilated to remove any unburned gas, the ignition process may cause an explosion.

CAUTION

-  Installation, wiring, inspection, adjustment, etc. should be carried out by a trained and experienced technician who has knowledge and technical skills related to combustion equipment and flame safeguard control devices.
-  Only an experienced technician who has knowledge and technical skills related to combustion equipment and combustion safety should carry out the pilot turndown test.

„ Outline of adjustment

The following test adjustment items are described in this chapter:

- Measurement of flame voltage
- Pilot turndown test
- Ignition spark response test
- Safety shutoff test

Handling Precautions

- After the above items have been adjusted, check again that each adjustment is satisfactory. It is absolutely necessary for all adjustments to be correct before the final positioning of the flame detector.
- Do not repeatedly turn the power supply switch ON and OFF. Doing so may cause incorrect operation. After turning the power OFF, wait at least 3 sec-onds before turning it ON.

⌘z Tools and parts needed

- Multimeter or FSP136A: Input impedance: 100 kΩ or more
AC range: 0 to 300 V
DC range: 0 to 10 V
- Jumper cables with clips: Two, AWG14 (2 mm²) min., approx. 30 cm long
- Insulation resistance tester: 500 V DC megger



Chapter 4. TRIAL-RUN ADJUSTMENT

„ Preliminary inspection

- (1) Inspect all wiring parts.
- (2) Check that the device is mounted in a place where the ambient temperature is within its allowable range.
- (3) Check that the AUD300C/500C is mounted correctly. In particular, be sure the blue lead wire (to terminal 1) and yellow lead wire (to terminal 2) of the AUD300C/500C are connected correctly. For details, refer to;
 AUD300C user's manual, No. CP-SP-1141E
AUD500C user's manual, No. CP-SP-1328E
- (4) Check that the valves and cocks of each fuel system are closed and that the in-side of the fuel chamber is vented sufficiently.
- (5) After items (1) to (4) above have been checked, supply the power and start the trial-run adjustment.

„ Measurement of flame voltage (flame signal)

Start the equipment and measure the voltage under several conditions, such as start-up operation and normal operation.

- (1) Set the FSP136A range to 7.5 V.
- (2) Connect the positive probe of the FSP136A to the FLAME VOLTAGE + terminal on this device and the negative probe to the FLAME VOLTAGE - terminal.
- (3) Check that the voltage is stable and 2.0 V DC or more.
Recommended flame voltage: Stable 2.0 V DC or more.
- (4) If the flame voltage fluctuates widely, check the AUD300C/500C's mounting position and wiring condition.

Handling Precautions

- Always use IV wire with a cross-sectional area of 0.75 mm² or more for signal lines. The wiring length must be 10 m or less.
- A measuring instrument connected to this device should have an input im-pedance of 100 k Ω or more.

Note

- Even during normal operation, the flame voltage is synchronized with the shutter operation of the AUD300C/500C and fluctuates between 0.1 to 0.3 V.
- On the device, the average flame voltage can be checked on the 7-segment display.

**„ Pilot turndown test**

This test is intended to check that the flame is reliably transferred to the main burner when the AUD300C/500C detects a pilot flame if the gas pressure and air pressure change to their worst conditions.

⚠ WARNING

Carry out the pilot turndown test carefully. If the flame detector is set so that it detects a pilot flame that is too small to ignite the main burner, this device will not be able to detect a flame failure in the main burner. In that case, fuel will continue to be supplied, causing a serious explosion hazard.



Before the pilot turndown test or ignition spark response test, make sure that all manual fuel valves are closed.



If the pilot turndown test must be carried out repeatedly, completely shut down all equipment each time the test is finished, and completely discharge unburned gas or fuel that has accumulated in the ducts and combustion chamber. Failure to discharge unburned gas or fuel may result in an explosion.



When the pilot turndown test is complete, turn OFF the power switch to shut down the power. Restore all test jumpers and limit interlock/regulator settings to their previous states. If operation begins without the above steps, damage to the equipment, gas leak or explosion may result.

⚠ CAUTION

Only an experienced technician who has knowledge and technical skills related to combustion equipment and combustion safety should carry out the pilot turndown test.

! Handling Precautions

- If a fuel pressure limit switch is used, and its contacts are open, turn it ON with a jumper cable during this test.

To carry out the pilot turndown test, follow the steps below.

⌘ Preparations for the test

- (1) Turn OFF the power switch.
- (2) Close the manual valves to stop the gas supply to the pilot burner and main burner.
- (3) Open the manual valve for the pilot burner.

⌘ Check a gas pressure level at which the Model AUD300C/500C cannot detect the pilot flame

- (4) Turn ON the power switch and press and hold the start switch.

>>The ignition operation begins, the pilot valve opens, and the ignition transformer is activated. The flame relay turns ON and the FLAME LED lights up.



Chapter 4. TRIAL-RUN ADJUSTMENT

- (5) Close the manual valve for the pilot burner slowly.
The pilot flame gradually becomes smaller. Gradually close the valve until the AUD300C/500C cannot detect the flame.
- (6) FLAME LED goes out, and the system is locked out. Record the gas pressure just before the lockout.

⌘z Check that the main burner ignites with the minimum pilot flame

- (7) Open the manual valve for the pilot slowly to adjust the pressure to a level immediately before the combustion lamp goes off.
- (8) Reset this device and turn ON the start contact again to ignite the pilot.
- (9) Check that the main burner ignites smoothly within 1 second after the manual valve for the main burner has opened.
- (10) Change the gas pressure level between the minimum and maximum levels and ignite the main burner five or six times. Be sure that the main burner ignites smoothly every time.

⌘z If the main burner does not ignite with the minimum pilot flame

- (11) Adjust the mounting position of the AUD300C/500C and the amount of incoming light so that the AUD300C/500C cannot detect a pilot flame that can-not ignite the main burner.
There are two kinds of adjustment procedures.
 - Move the monitoring area of the sighting pipe slightly away from the pilot flame.
 - Narrow the sighting pipe to decrease the incoming light amount from the pilot flame.
- (12) Open the manual valve for the pilot burner slowly to make the pilot flame larger than the previous flame.

⌘z After adjustment, check again that the main burner ignites with the minimum pilot flame

- (13) Perform steps 7 to 10 to be sure that the main burner still ignites with the minimum pilot flame.

⌘z Measures to be taken after completion of the test

- (14) After the test has been completed, return the manual valve of the main burner to its fully open position.
- (15) Check that the flame voltage is correct.
- (16) If any limit switch has jumper cables attached, disconnect them to return the limit switch to its previous state.



„ Ignition spark response test

WARNING



Make sure that the AUD300C/500C does not detect ultraviolet rays other than those of the burner. If the AUD300C/500C responds to other ultraviolet rays, flame failure in the burner will not be detected. As a result, fuel will continue to be discharged, causing a serious explosion hazard.

- (1) Close the manual fuel valves of the pilot and main burners.
- (2) Begin operation and measure the flame voltage in the pilot ignition sequence to check whether or not the flame voltage is influenced.
- (3) If the FLAME LED is lit, make adjustments using the following procedures while referring to the instruction manual for the equipment:
 - Move the AUD300C/500C or ignition spark rod so that there is no influence.
 - Put a shielding plate in the optical path of the AUD300C/500C so that the effect of the spark is a flame signal of 0.4 V DC or less.



Handling Precautions

- Be sure the AUD300C/500C does not detect ultraviolet rays other than those of the burner flame.

The following shows various ultraviolet ray sources other than the burner flame that may activate the AUD300C/500C:

Ultraviolet ray source	Red-hot furnace walls (1371 °C or more, within 50 cm of furnace wall)
	Ignition transformer and welding arc
	Gas laser
	Sunlamp
	Disinfecting lamp, ultraviolet lamp, fluorescent lamp
	Strong flashlight (toward UV sensor)
Gamma-ray and X-ray source	X-ray diffraction and gamma-ray analysis measurement equipment
	Electron microscope
	X-ray camera
	High voltage vacuum switch
	High voltage capacitor
	Radioisotope
	Other sources producing ultraviolet rays, gamma-rays, and X-rays



Chapter 4. TRIAL-RUN ADJUSTMENT

„ Safety shutoff test

After all operational adjustments have been completed, carry out the safety shutoff test.

⌘z Pilot ignition failure (ignition failure)

- (1) Close the pilot and main manual fuel valves.
- (2) Press the start switch.
>>Operation begins.
- (3) Normally, for pilot burner ignition, the pilot valve opens. Check that there is lockout with the FLAME LED not lit so that the main valve does not open if the flame fails.

⌘z Flame failure during RUN-state

- (1) Open the pilot and main manual fuel valves.
- (2) Press the start switch to begin operation.
- (3) When the sequence has progressed correctly and RUN has begun (main valve has opened), close the pilot and main manual fuel valves to put out the burner flame. Then, check that flame failure is detected and that safety shutoff is correctly activated.

⌘z Interlock operation check

Activate each interlock, and check that the system is locked out.

Handling Precautions

- Be sure to continue the reset input for more than 1 second. A reset input less than 1 second long may not cancel the lockout



Chapter 5. MAINTENANCE AND INSPECTION

WARNING



Before wiring, mounting, or removing this device, be sure to turn the power off. Wiring with the power on can result in an electric shock.



Terminals and the connected flame detector signal cable retain an electrical charge even after the power is turned OFF. To avoid electric shock, do not touch terminals F and G or the cable immediately after power-off.

CAUTION



Installation, wiring, inspection, adjustment, etc. should be carried out by a trained and experienced technician who has knowledge and technical skills related to combustion equipment and flame safeguard control devices.



If the safety shutoff has been activated, check all of the items on the checklists in chapter 4, TRIAL-RUN ADJUSTMENT before restarting the equipment.



When doing a maintenance inspection of the burner, be sure to do the pilot turndown test. Inspection must be done at least once a year.



Conduct periodic inspections in accordance with the user's manual of the equipment manufacturer.



When cleaning the burner, clean the flame detector as well.

„ Frequency of maintenance and inspection

Determine an appropriate frequency for maintenance and inspection work by considering

- the equipment type
- ambient conditions (dust or temperature) of the location
- damage or negative effects if the burner is shut off

for some reason during operation of the equipment.

Inspections	Inspection frequency
Safety shutoff test (for details, refer to;  Chapter 4. TRIAL-RUN ADJUSTMENT).	Once a month or more
Contamination of monitoring window and sighting pipe of AUD300C/500C	Once a month or more
Measurement of flame voltage	Once a month or more
Pilot turndown test	Once a year or more



Handling Precautions

- If unintended burner shutoff may cause a serious problem, perform the inspection more frequently.
- If the burner manufacturer provides specific instructions about maintenance and inspection, always strictly observe them.
- Always use IV wire with a cross-sectional area of 0.75 mm² or more for flame voltage output. The wire length must be 10 m or less.
A measuring instrument connected to this device should have an input impedance of 100 kΩ or more.



บริษัท เอดีดี เฟอร์เนส จำกัด

ADD FURNACE CO.,LTD.

44 ซอยบรมราชชนนี 70 ถนนบรมราชชนนี แขวงศาลาธรรมสพน์ เขตทวีวัฒนา กรุงเทพฯ 10170

โทร: 02-888-3472 โทร.) ออกแบบ:(08-08-170-170 แฟกซ์: 02-888-3258

<https://www.add-furnace.com> E-mail: sales@add-furnace.com

Chapter 5. MAINTENANCE AND INSPECTION

„ Alarm code and description

When lockout occurs an alarm code is automatically displayed. When the alarm is activated, the lockout sequence code and the alarm code are displayed alternately.

Display	Alarm name	Description
E0	Start check alarm	The start check was not completed for some reason such as momentary power failure or part malfunction.
E1	Interlock alarm	Interlock occurred.
E2	False flame	A false flame such as a remaining flame was detected.
E3	UV alarm	A flame was detected even though the shutter output was off.
E4	Ignition failure	No flame was detected at the completion of the ignition trial.
E5	Flame failure	A flame failure occurred in the following sequence: <ul style="list-style-type: none">• Pilot Stabilization• Main trial• RUN
EE	Other	When the cause of lockout cannot be identified: <ul style="list-style-type: none">• In cases where power was turned off before CPU error determination• In cases where vibration during transportation, etc., cause latch relay to switch to lockout

Handling Precautions

- When the DISP switch is pressed while an alarm code is displayed, the display changes to flame voltage.
- When lockout is reset, the display reverts to its state before lockout.



„ Fault inspection flowchart

WARNING

Before wiring, mounting, or removing this device, be sure to turn the power off. Wiring with the power on can result in an electric shock.

When there is a problem with the equipment, follow the following inspection procedure:

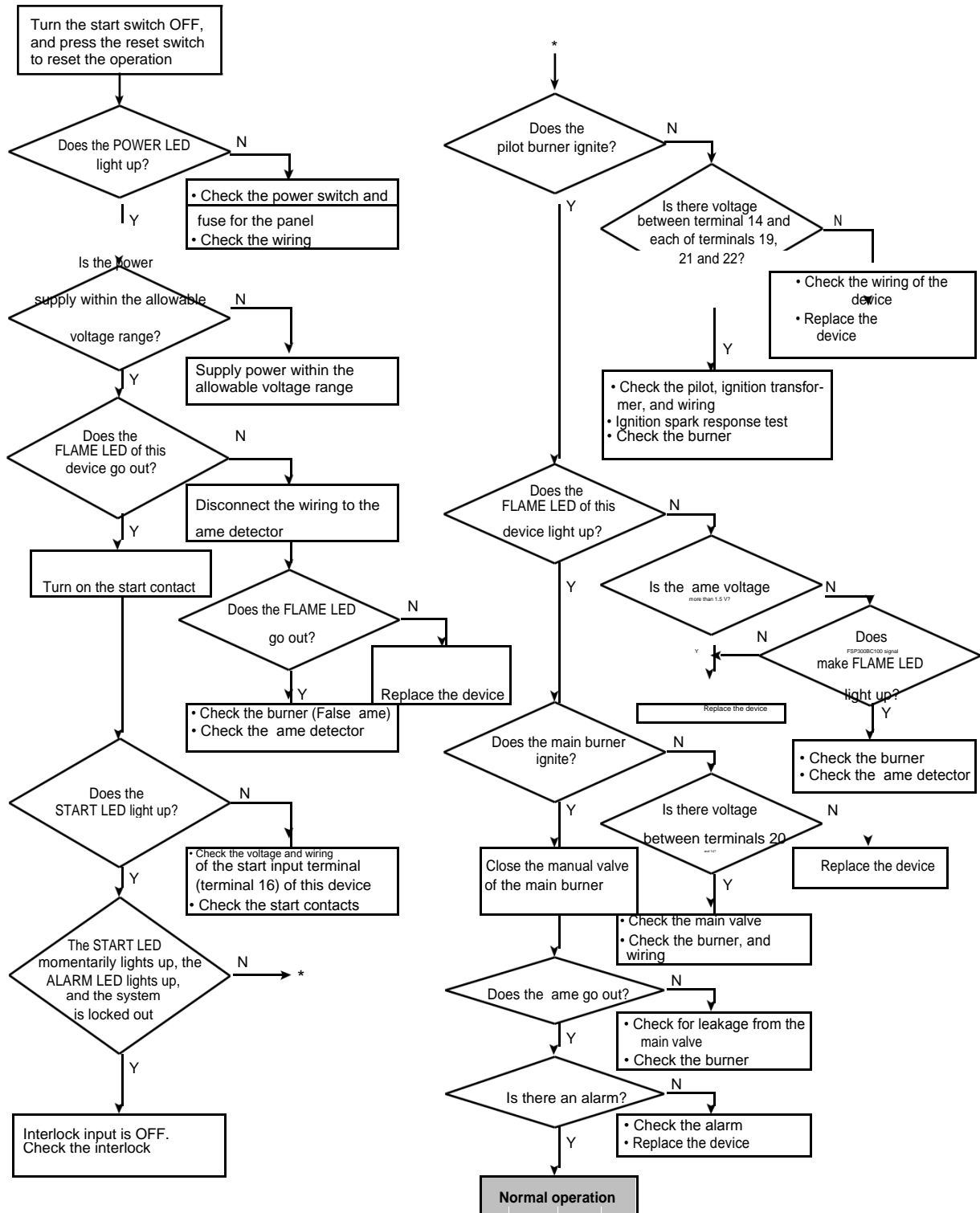



บริษัท เอดีดี เฟอร์เนส จำกัด

ADD FURNACE CO.,LTD.

44 ซอยบรมราชชนนี 70 ถนนบรมราชชนนี แขวงศาลาธรรมสพน์ เขตทวีวัฒนา กรุงเทพฯ 10170

โทร: 02-888-3472 โทร.) ออกแบบ:(08-08-170-170 แฟกซ์: 02-888-3258

https://www.add-furnace.com E-mail: sales@add-furnace.com

Chapter 5. MAINTENANCE AND INSPECTION

Use this sheet when checking controller status for inspection or troubleshooting

Flame Detector and Burner Controller Status Checklist

Date: Yr. __ Mo. __ Day __

Fill in the blanks and check the applicable boxes.

Ckd by : _____

End user name/equipment maker name:		Equipment name/production line name or number:	
Controller model No.:	Date code/date mfd.:	Date delivered:	
<p>● Wiring and mounting</p> <p>1. Power supply source, instrumentation, electric power, primary/secondary transformer voltage, etc. Protectorelay power supply voltage: _____ V AC</p> <p>Was there a prolonged/instantaneous power failure, or a voltage drop/surge? <input type="checkbox"/> Yes <input type="checkbox"/> No</p> <p>2. Wiring material, diameter, distance, temperature, maker name, etc.: Power supply _____ wire: Signal wire: _____ Ground wire: _____</p> <p>3. Mounting <input type="checkbox"/> Indoors <input type="checkbox"/> Equipment room <input type="checkbox"/> Outdoors Device cover? <input type="checkbox"/> Yes <input type="checkbox"/> No</p> <p>4. Dirt or dust on UV ray detector glass <input type="checkbox"/></p> <p>5. UV sensor signal line/F-G wiring check: <input type="checkbox"/> OK <input type="checkbox"/> Reversed connection</p>		<p>● Flame current/voltage</p> <p>1. During pilot combustion While ignition transformer is on: _____ $\mu A/V$ While ignition transformer is o : _____ $\mu A/V$</p> <p>2. During main burner combustion During main burner ignition Min. _____ $\mu A/V$ Max. _____ $\mu A/V$ Normal _____ $\mu A/V$</p> <p>3. Length of operation (years, months) and operation frequency:</p>	
<p>● Environment</p> <p>1. Ambient temperature: _____</p> <p>2. Ambient humidity: _____</p> <p>3. Dew condensation: _____</p> <p>4. Corrosive atmosphere: _____</p> <p>5. Other: _____</p>		<p>● Equipment</p> <p>1. Main burner Model: Maker _____ name: _____ Capacity: _____ kW(Kcal/h)</p> <p>2. Pilot burner Model: Maker _____ name: _____ Capacity: _____ kW(Kcal/h)</p> <p>3. Fuel type and composition Pilot burner: _____ Main burner: _____</p> <p>4. Valve train (draw in the space below.)</p>	
<p>Special notes: Flame detector mounting drawing, control mode (ON/OFF, proportional, etc.), equipment drawing, valve train, environment (layout, ammable materials, hazardous materials, obstacles)</p>			



Chapter 6. SPECIFICATIONS

„ Specifications

⌘z General specifications

Item	Description
Compatible flame detector	AUD300C, AUD500C
Start check time	For normal operation: 2 s max. If alarm is detected: 10 ± 2 s
Ignition trial	4 ± 1 s or 8 ± 2 s depending on model
Pilot Stabilization (Pilot only time)	7.5 ± 2.5 s
Main trial time	7 ± 3 s
Start check error detection time	10 ± 2 s
Flame failure response time (at flame voltage of 3 V DC)	Nominal 1.5 s (max. 2 s), nominal 3 s (max. 4 s)
Reset response time	1 s or more
Range of flame voltage output	0 to 5 V IV wire 0.75 mm ² min. for signal line, wiring length of 10 m max. Input impedance of connected instruments: 100 kΩ min.
Flame voltage range (at rated voltage, room temp, and humidity)	Flame-out detection: 0.0 to 0.6 V DC Flame establishment: 1.5 to 4.0 V DC
Recommended flame voltage	Stable 2.0 V DC or more
Service life	7 years or 100,000 operation cycles max. (at room temperature and humidity and rated voltage and load)
Max. tightening torque	Subbase mounting screws: 1.5 N•m or less Body-subbase screw: 0.5 N•m or less M3.5 terminal screws: 1.0 N•m or less
Mounting method	Mounted on subbase
Subbase	Q241A104
External dimensions	103 mm (D) X 103 mm (W) X 105 mm (H) (Total height including subbase is 136 mm)
Color	Black
Mass	Approx. 600 g (approx. 830 g including subbase)
Pollution degree	2
Protection rating	IP20
Certificates * ₁	UL: File No. MH27717 CE: Gas Appliance Directive (2009/142/EC) 0063BS1427 * ₂ Low Voltage Directive (2014/35/EU) Electromagnetic compatibility Directive (2014/30/EU) RoHS Directive (2011/65/EU) FM: File No. 0003059531

*₁. Certificates are valid only for a combination of AUR450C, AUD300C, and Q241A104.*₂. from 21st April 2018 GAR 2016/426



บริษัท เอดีดี เฟอร์เนส จำกัด

ADD FURNACE CO.,LTD.

44 ซอยบรมราชชนนี 70 ถนนบรมราชชนนี แขวงศาลาธรรมสพน์ เขตทวีวัฒนา กรุงเทพฯ 10170

โทร: 02-888-3472 โทร.) ออกแบบ:(08-08-170-170 แฟกซ์: 02-888-3258

<https://www.add-furnace.com> E-mail: sales@add-furnace.com

Chapter 6. SPECIFICATIONS

⌘z Electrical specifications

Item	Description
Power supply voltage	100/120/200/230 V AC 50/60 Hz
Allowable voltage range	85 to 110 % of power supply voltage
Power consumption	15 W max. (including both AUR450C and AUD300C/500C)
Dielectric strength	1500 V AC, 50/60 Hz for 1 min, between ground and primary terminals 11 to 24, or 1800 V AC, 50/60 Hz for 1 s.
Insulation resistance	50 MΩ min. with 500 V DC megger between ground and primary terminals (11 to 24)

⌘z Communication specifications

Item	Description
Transmission mode	Balanced
Transmission line	3-wire system
Transmission speed (bps)	1200, 2400, 4800, 9600, 19200
Transmission distance	500 m max.
Communications system	Half duplex
Synchronization	Start-stop
Data format	8 bits, 1 stop bit, even parity 8 bits, 2 stop bits, no parity
Error detection	Parity check
Station address	0 to F (at 0, communications are disabled)
Connection method	1:N (15 units max.)
Terminating resistor	Use prohibited (resistor already built in)
Signal level	RS-485 compliant

⌘z Environment specifications

Item	Description
Allowable ambient temperature	Stand-alone mounting: -20 to +55 °C Side-by-side mounting of multiple devices and intervals of less than 100 mm: -20 to +45 °C
Storage temperature	-20 to +70 °C
Ambient humidity	90 % RH at 40 °C (without condensation)
Vibration resistance	During operation: amplitude 0.5 mm p-p, frequency 10 to 55 Hz for 2 h each in X, Y and Z directions. During transportation/storage: amplitude 0.75 mm p-p, frequency 10 to 55 Hz for 2 h each in X, Y and Z directions.
Impact resistance	During operation: 0 to 49 m/s ² , During transportation/storage: 0 to 300 m/s ²



Chapter 6. SPECIFICATIONS

„ External dimensions

Unit: mm

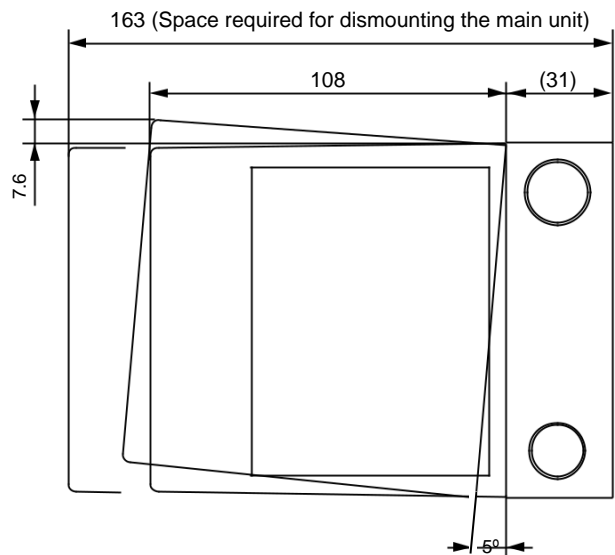
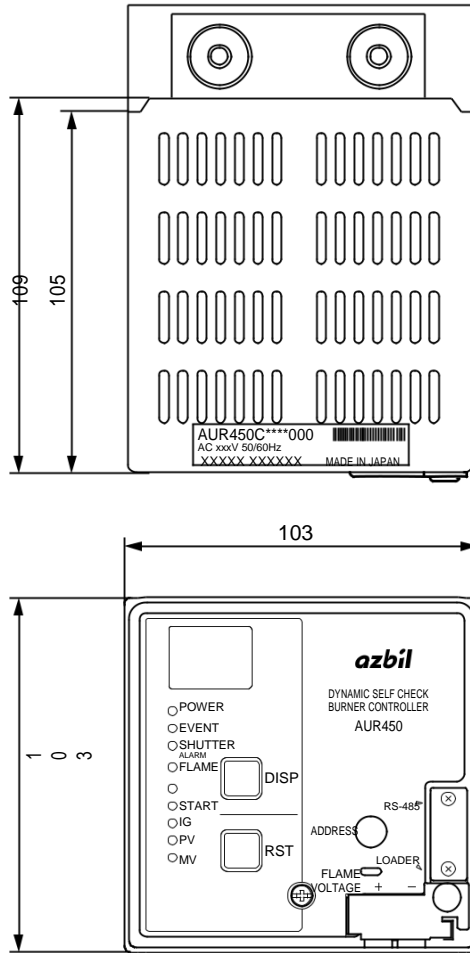

Note) When dismantling the main unit, pull it out while tilting it as shown in the drawing.

„ China RoHS

「电子电气产品有害物质限制使用标识要求」的表示式样
产品中有害物质的名称及含量

部件名称	有害物质					
	铅 (Pb)	汞 (Hg)	镉 (Cd)	六价铬 (Cr(VI))	多溴联苯 (PBB)	多溴二苯醚 (PBDE)
印刷电路板组装	×	○	○	○	○	○
副底座 (另售品)	×	○	○	○	○	○

本表格依据SJ/T 11364 的规定编制。
○: 表示该有害物质在该部件所有均质材料中的含量均在GB/T 26572规定的限量要求以下。
×: 表示该有害物质至少在该部件的某一均质材料中的含量超出GB/T 26572规定的限量要求。





บริษัท เอดีดี เฟอร์เนส จำกัด

ADD FURNACE CO.,LTD.

44 ซอยบรมราชชนนี 70 ถนนบรมราชชนนี แขวงศาลาธรรมสพน์ เขตทวีวัฒนา กรุงเทพฯ 10170

โทร: 02-888-3472 โทร.) ออกแบบ(:08-08-170-170 แฟกซ์: 02-888-3258

<https://www.add-furnace.com> E-mail: sales@add-furnace.com

Memo



Revision History (CP-SP-1264E)

Printed	Edn.	Revised pages	Description
June 2007	1		
Jan. 2010	2		Overall revision
May 2010	3	vii 1-1 1-3 2-7 3-7, 3-8 4-2 6-1 6-2	Delete Manual No. CP-SP-1170E and CP-SP-1211E. Delete AUR400C. ■ Overview explanation changed. ■ Model selection table conditions added. Figure changed. Graph corrected. Explanation changed. ● General specifications explanation added. ● Environment specifications explanation added.
Oct. 2012	4	vii 1-3 1-4 1-6 1-8 2-5 2-7 3-1 3-2, 3-11 3-9 4-2 4-5 5-2 6-2 6-4, 6-5 End of a book	Company name changed. Reference manual changed from CP-SP-1181E to CP-SP-1328E Flame failure response time 3 deleted. Table changed Sequence code display: PL added to the table. Alarm code display: EE added to the table. Subbase terminal block: table changed. Caution added. Explanation changed. ■ Explanation added to precautions for instrumentation and circuit configuration with an interrupted pilot. Internal block diagram changed. Time chart changed. ■ Preliminary inspection: Reference manual changed from CP-SP-1181E to CP-SP-1328E. Handling Precautions: Explanation about ultraviolet ray source changed. Alarm code display: EE added to the table. ● Environment specifications: Allowable ambient temperature changed. EC DECLARATION OF CONFORMITY changed. Terms and Conditions was changed.
Feb. 2013	5	1-1 1-4 6-1	The table was deleted. Certificates were added. “Approvals” was changed to “Certificates.” Standards compliance section was deleted from “Specifications.” Certificates were added to “Specifications.”
Oct. 2017	6	iv, 2-1 1-1, 1-4, 6-1 1-3 6-3 6-4, 6-5 6-6, 6-7 End of a book	“CSA” was deleted. Certificates were changed. Table was changed. Information on China RoHS was added. EC DECLARATION OF CONFORMITY changed. Instructions for Safe Use was added. Terms and Conditions were changed (to version No. AA511A-014-09).
May 2018	7	iii 2-1 3-2, 3-11 3-10 6-4 to 6-7	Warnings were added. A Caution was added. A Caution was added. Internal block diagram changed. Descriptions in “Precautions for instrumentation and circuit configuration with an intermittent pilot” were changed. EC DECLARATION OF CONFORMITY deleted.
Sep. 2019	8	2-6 End of a book	Handling Precautions was changed. Terminal numbers in the figure in “Connecting to a surge absorber” were changed. Terms and Conditions were changed (to version No. AA511A-014-10).



Terms and Conditions

We would like to express our appreciation for your purchase and use of Azbil Corporation's products. You are required to acknowledge and agree upon the following terms and conditions for your purchase of Azbil Corporation's products (system products, field instruments, control valves, and control products), unless otherwise stated in any separate document, including, without limitation, estimation sheets, written agreements, catalogs, specifications and instruction manuals.

1. Warranty period and warranty scope

1.1 Warranty period

Azbil Corporation's products shall be warranted for one (1) year from the date of your purchase of the said products or the delivery of the said products to a place designated by you.

1.2 Warranty scope

In the event that Azbil Corporation's product has any failure attributable to azbil during the aforementioned warranty period, Azbil Corporation shall, without charge, deliver a replacement for the said product to the place where you purchased, or repair the said product and deliver it to the aforementioned place.

Notwithstanding the foregoing, any failure falling under one of the following shall not be covered under this warranty:

- (1) Failure caused by your improper use of azbil product (noncompliance with conditions, environment of use, precautions, etc. set forth in catalogs, specifications, instruction manuals, etc.);
- (2) Failure caused for other reasons than Azbil Corporation's product;
- (3) Failure caused by any modification or repair made by any person other than Azbil Corporation or Azbil Corporation's subcontractors;
- (4) Failure caused by your use of Azbil Corporation's product in a manner not conforming to the intended usage of that product;
- (5) Failure that the state-of-the-art at the time of Azbil Corporation's shipment did not allow Azbil Corporation to predict; or
- (6) Failure that arose from any reason not attributable to Azbil Corporation, including, without limitation, acts of God, disasters, and actions taken by a third party.

Please note that the term "warranty" as used herein refers to equipment-only-warranty, and Azbil Corporation shall not be liable for any damages, including direct, indirect, special, incidental or consequential damages in connection with or arising out of Azbil Corporation's products.

2. Ascertainment of suitability

You are required to ascertain the suitability of Azbil Corporation's product in case of your use of the same with your machinery, equipment, etc. (hereinafter referred to as "Equipment") on your own responsibility, taking the following matters into consideration:

- (1) Regulations and standards or laws that your Equipment is to comply with.
- (2) Examples of application described in any documents provided by Azbil Corporation are for your reference purpose only, and you are required to check the functions and safety of your Equipment prior to your use.
- (3) Measures to be taken to secure the required level of the reliability and safety of your Equipment in your use

Although azbil is constantly making efforts to improve the quality and reliability of Azbil Corporation's products, there exists a possibility that parts and machinery may break down.

You are required to provide your Equipment with safety design such as fool-proof design, 1 and fail-safe design 2 (anti-flame propagation design, etc), whereby preventing any occurrence of physical injuries, fires, significant damage, and so forth. Furthermore, fault avoidance, *3 fault tolerance 4 or the like should be incorporated so that the said Equipment can satisfy the level of reliability and safety required for your use.

*1. A design that is safe even if the user makes an error.

*2. A design that is safe even if the device fails.

*3. Avoidance of device failure by using highly reliable components, etc.

*4. The use of redundancy.

3. Precautions and restrictions on application

Azbil Corporation's products other than those explicitly specified as applicable (e.g. azbil Limit Switch For Nuclear Energy) shall not be used in a nuclear energy controlled area (radiation controlled area).

Any Azbil Corporation's products shall not be used for/with medical equipment.

The products are for industrial use. Do not allow general consumers to install or use any Azbil Corporation's product.

However, azbil products can be incorporated into products used by general consumers. If you intend to use a product for that purpose, please contact one of our sales representatives.

In addition,

you are required to conduct a consultation with our sales representative and understand detail specifications, cautions for operation, and so forth by reference to catalogs, specifications, instruction manual, etc. in case that you intend to use azbil product for any purposes specified in (1) through (6) below.

Moreover, you are required to provide your Equipment with fool-proof design, fail-safe design, anti-flame propagation design, fault avoidance, fault tolerance, and other kinds of protection/safety circuit design on your own responsibility to ensure reliability and safety, whereby preventing problems caused by failure or nonconformity.

- (1) For use under such conditions or in such environments as not stated in technical documents, including catalogs, specification, and instruction manuals
- (2) For use of specific purposes, such as:
 - * Nuclear energy/radiation related facilities
 - [For use outside nuclear energy controlled areas] [For use of Azbil Corporation's Limit Switch For Nuclear Energy]



บริษัท เอดีดี เฟอร์เนส จำกัด

ADD FURNACE CO.,LTD.

44 ซอยบรมราชชนนี 70 ถนนบรมราชชนนี แขวงศาลาธรรมสพน์ เขตทวีวัฒนา กรุงเทพฯ 10170

โทร: 02-888-3472 โทร.ออกเบบ(:08-08-170-170 แฟกซ์: 02-888-3258

<https://www.add-furnace.com> E-mail: sales@add-furnace.com

- *Machinery or equipment for space/sea bottom
- *Transportation equipment
[Railway, aircraft, vessels, vehicle equipment, etc.]
- *Antidisaster/crime-prevention equipment

- (1) For use under such conditions or in such environments as not stated in technical documents, including catalogs, specification, and instruction manuals
- (2) For use of specific purposes, such as:
 - * Nuclear energy/radiation related facilities
[When used outside a radiation controlled area and where nuclear power quality is not required]
[When the limit switch for nuclear power is used]
 - * Machinery or equipment for space/sea bottom
 - * Transportation equipment
[Railway, aircraft, vessels, vehicle equipment, etc.]
 - *Antidisaster/crime-prevention equipment
 - *Burning appliances
 - *Electrothermal equipment
 - *Amusement facilities
 - * Facilities/applications associated directly with billing
- (3) Supply systems such as electricity/gas/water supply systems, large-scale communication systems, and traffic/air traffic control systems requiring high reliability
- (4) Facilities that are to comply with regulations of governmental/public agencies or specific industries
- (5) Machinery or equipment that may affect human lives, human bodies or properties
- (6) Other machinery or equipment equivalent to those set forth in items (1) to (5) above which require high reliability and safety

4.Precautions against long term use

Use of Azbil Corporation's products, including switches, which contain electronic components, over a prolonged period may degrade insulation or increase contact-resistance and may result in heat generation or any other similar problem causing such product or switch to develop safety hazards such as smoking, ignition, and electrification. Although acceleration of the above situation varies depending on the conditions or environment of use of the products, you are required not to use any Azbil Corporation's products for a period exceeding ten (10) years unless otherwise stated in specifications or instruction manuals.

5.Recommendation for renewal

Mechanical components, such as relays and switches, used for Azbil Corporation's products will reach the end of their life due to wear by repetitious open/close operations.

In addition, electronic components such as electrolytic capacitors will reach the end of their life due to aged deterioration based on the conditions or environment in which such electronic components are used. Although acceleration of the above situation varies depending on the conditions or environment of use, the number of open/close operations of relays, etc. as prescribed in specifications or instruction manuals, or depending on the design margin of your machine or equipment, you are required to renew any Azbil Corporation's products every 5 to 10 years unless otherwise specified in specifications or instruction manuals. System products, field instruments (\$ensors such as pressure/flow/level sensors, regulating valves, etc.) will reach the end of their life due to aged deterioration of parts. For those parts that will reach the end of their life due to aged deterioration, recommended replacement cycles are prescribed. You are required to replace parts based on such recommended replacement cycles.

ng

6.Other precautions.

Prior to your use of Azbil Corporation's products, you are required to understand and comply with specifications (e.g., conditions and environment of use, precautions, warnings/cautions/notices as set forth in the technical documents prepared for individual Azbil Corporation's products, such as catalogs, specifications, and instruction manuals to ensure the quality, reliability, and safety of those products.

7.Changes to specifications

Please note that the descriptions contained in any documents provided by azbil are subject to change without notice for improvement or for any other reason. For inquiries or information on specifications as you may need to check, please contact our branch offices or sales offices, or your local sales agents.

8. Discontinuance of the supply of products/parts

Please note that the production of any Azbil Corporation's product may be discontinued without notice. After manufacturing is discontinued, we may not be able to provide replacement products even within the warranty period.

For repairable products, we will, in principle, undertake repairs for five (5) years after the discontinuance of those products. In some cases, however, we cannot undertake such repairs for reasons, such as the absence of repair parts. For system products, field instruments, we may not be able to undertake parts replacement for similar reasons.

9. Scope of services

Prices of Azbil Corporation's products do not include any charges for services such as engineer dispatch service. Accordingly, a separate fee will be charged in any of the following cases:

- (1) Installation, adjustment, guidance, and attendance at a test run
- (2) Maintenance, inspection, adjustment, and repair
- (3) Technical guidance and technical education
- (4) Special test or special inspection of a product under the conditions specified by you

Please note that we cannot provide any services as set forth above in a nuclear energy controlled area (radiation controlled area) or at a place where the level of exposure to radiation is equivalent to that in a nuclear energy controlled area.