

## Compact pressure switches for gas and air GW...A6 GW...A6/1

**DUNGS**<sup>®</sup>  
Combustion Controls



### Technical description

The pressure switch GW...A6 is an adjustable compact pressure switch according to EN 1854 for combustion plants.

The pressure switches are suitable for **switch-on, switch-off and switch-over of an electric circuit at a variable pressure actual value, relative to the set desired value. The setpoint (switching point) is set on an adjusting wheel with scale.** A test nipple is integrated in the metal housing as standard.

### Application

Pressure monitoring in combustion, **ventilation and air-conditioning technologies.** Suitable for gases of families 1,2,3 and other neutral gaseous media.

### Approvals

**EC type testing certificate as per:**

- EC-Gas Appliances Regulation
- **EC-Pressure Equipment Directive**

Pressure switch class „S“ as per EN 1854.

**Approvals in other important gas-consuming countries.**

**Functional description**

**Single-acting pressure switch in over-pressure range.**  
 The pressure switches operate without any power supply.

**Switching response**

**GW...A6**

Short response time during pressure fluctuations.

**GW...A6/1**

Slow response time during short-term pressure fluctuations by additional damping nozzle.

**GW...A6 pressure switch**

The control unit responds to pressure. If the setpoint is exceeded or undershot, **the circuit is switched on, off or over.**

**GW... / ...A6 double pressure switch**

Combination of two flanged GW...A6 single pressure switches. The two setpoints are set separately and independently. **A combination of different setpoint ranges is therefore possible.** The two control units are fed from the same medium at the medium's pressure.

**Switching function**

**If pressure increases:**  
 1 NC opens, 2 NO closes.  
**If pressure drops:**  
 1 NC closes, 2 NO opens.

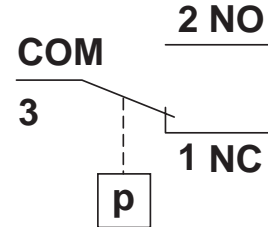

**Definition of  $\Delta p$  switching difference**

The  **$\Delta p$  switching difference is the pressure difference between the upper and lower switching pressure.**

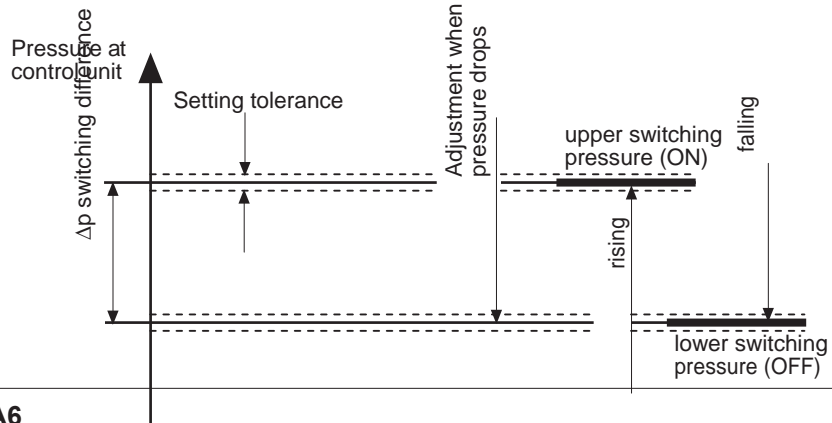

**Switching difference  $\Delta p$  @ GW...A5/A6**  
**Depending on the corresponding set value ( $p \downarrow$ )**

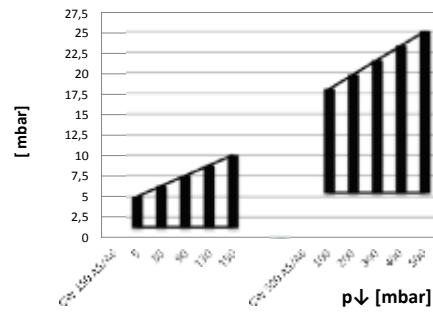
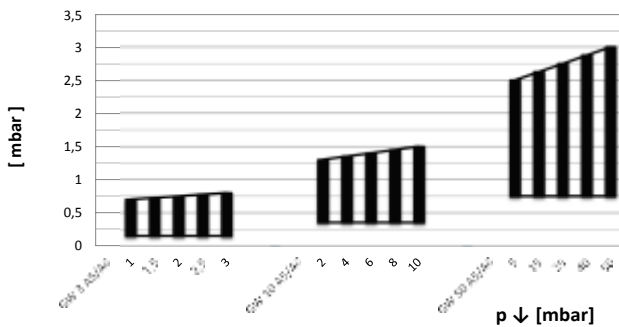

**Specifications**

Max. operating pressure	<b>GW 3 A6 - GW 150 A6</b> <b>GW 500 A6</b>	<b>500 mbar</b> <b>600 mbar</b>	<b>(50 kPa)</b> <b>(60 kPa)</b>
Pressure connection	<b>Standard (V0):</b> <b>Special design (V3):</b>	<b>centrally on housing bottom, G 1/4 inner thread</b> as per ISO 228 <b>additionally G 1/4 inner thread (side right)</b>	
Measuring connection	Test nipple integrated in metal housing $\varnothing 9$		
Temperature range	Ambient temperature -15 °C to +70 °C Medium temperature -15 °C to +70 °C Storage temperature -30 °C to +80 °C		
Materials	<b>Housing:</b> <b>Switch part:</b> <b>Diaphragms:</b> <b>Switching contact:</b>	<b>Aluminium die cast</b> <b>Polyamide</b> <b>NBR</b> <b>Ag</b>	
Switching voltage	<b>AC eff. min. 24 V</b> <b>DC min. 24 V</b>	<b>max. 250 V</b> <b>max. 48 V</b>	
Nominal current	<b>GW 10...500 A6</b> <b>AC eff. max. 10 A</b>	<b>GW 3 A6</b> <b>AC eff. max. 6 A</b>	
Switching current	<b>AC eff. max. 6 A at <math>\cos \varphi 1</math></b> <b>AC eff. max. 3 A at <math>\cos \varphi 0,6</math></b> <b>AC eff. min. 20 mA</b> DC min. 20 mA DC max. 1 A	<b>AC eff. max. 4 A at <math>\cos \varphi 1</math></b> <b>AC eff. max. 2 A at <math>\cos \varphi 0,6</math></b> <b>AC eff. min. 20 mA</b> DC min. 20 mA DC max. 1 A	
Electrical connection	<b>Terminal connection for line sockets as per DIN EN 175 301-803, 3-pin,</b> protection-insulated without ground connection		
Degree of protection	<b>IP 54 as per IEC 529 (EN 60529)</b>		
Setting tolerance	<b><math>\pm 15\%</math> switch point deviation referred to setpoint, adjusted for dropping pressure, vertical diaphragm position</b>		
Deviation	<b>Permissible deviation of the set value <math>\leq \pm 15\%</math> in the service life test according to EN 1854</b>		

**Mounting options GW...A6**  
**Safety solenoid valve**  
**SV-... 505-520**

Pressure tap GW...A6 mounting possible ...	
1	no
2	no
3	pe (p <sub>1</sub> )
4	pa (p <sub>2</sub> )

Pressure tap 3

Pressure tap 4

Pressure tap 1

Pressure tap 2

**Dimensions [mm]**

**GW ... A6, A6/1**

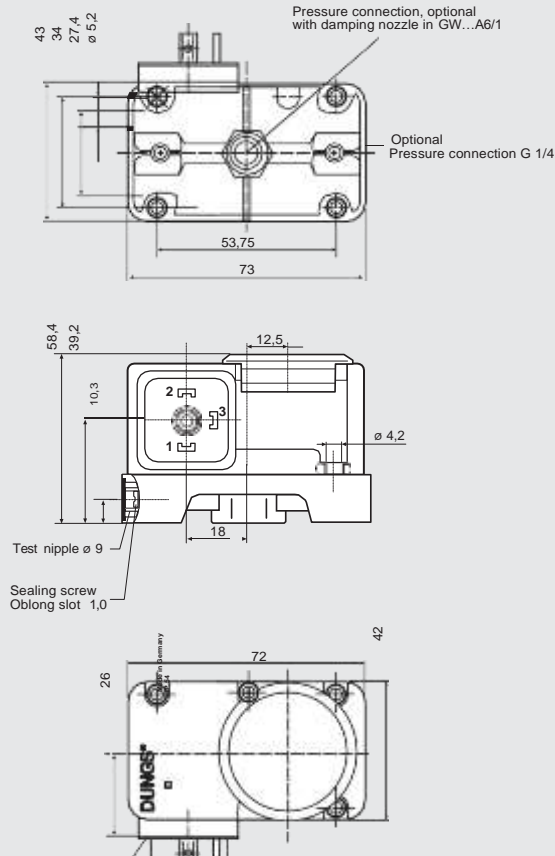

**Installation position**

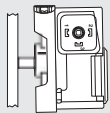

**Standard installation position; if a different installation position is used, pay attention to the changed operating points:**

- GW 3...50 A6**                      **approx. ± 0,6 mbar**
- GW 150 A6**                        **approx. ± 1 mbar**
- GW 500 A6**                        **approx. ± 3 mbar**

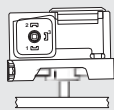

**When installed horizontally, the pressure switch switches at a pressure higher.**

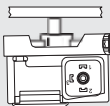

**When installed horizontally overhead, the pressure switch switches at a pressure lower.**

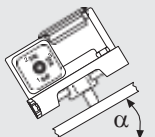

**When installed in an intermediate installation position, the pressure switch switches at pressure deviating from the set reference value.**

**Designation**

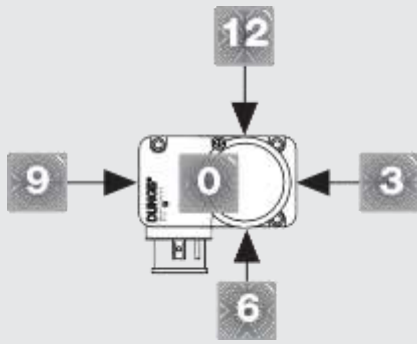

**Order example**

**Pressure switch design**

Pressure switch GW...A6

**Setting range**

**0,5 - 15 kPa (5-150 mbar)**

**Contact material**

Ag

**Electrical connection**

Equipment connector

**Pressure connection**

**G 1/4 at position 0**

**Test nipple**

MS 9

**Sealing screw**

At position 3

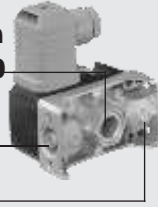

**GW 150 A6 [Ag-G3-MS9-V0-VS3]**

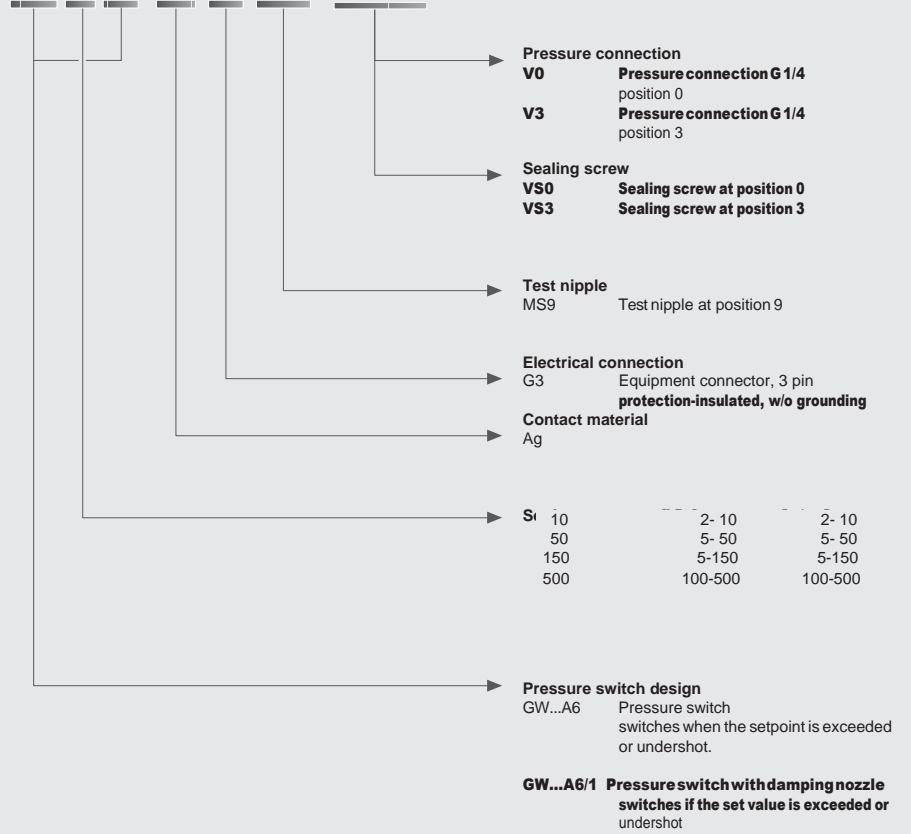

**GW 150 A6 [Ag-G3-MS9-V0-VS3]**

**Accessories for GW A6 pressure switch**

<b>Line sockets, 3-pin + grounding, grey GDMW</b>	210 318
<b>Test nipple G 1/4 with sealing ring (1 x)</b>	266 042
<b>Sealing screw G 1/4 with sealing ring (1 x)</b>	266 044
<b>Mounting kit for double pressure switch</b>	213 910
<b>Mounting bracket, metal</b>	230 288
<b>Mounting kit GW...A6 (for fitting to SV)</b>	242 771

Compact pressure switches for gas and air  
 GW...A6 GW...A6/1

Double pressure switch

GW... / ...A6



Short technical overview      **1 kPa = 10 mbar = 1000 Pa ≈ 100 mm WS**

Type	Design [Ag-G3-MS9-V0]	Order number (1 piece)	Order number (80 pieces)	Setting range [mbar]	max.	Switching difference Δp [mbar]		
						p ↓min.	p ↓max.	
GW...A6 pressure switch	GW 3 A6	272 343	228 723	1 - 3	± 15 %		≤ 0,7	≤ 0,8
	GW 10 A6	272 620	228 724	2 - 10	± 15 %		≤ 1,3	≤ 1,5
	GW 50 A6	272 615	228 725	5 - 50	± 15 %		≤ 2,5	≤ 3
	GW 150 A6	272 616	228 726	5 - 150	± 15 %		≤ 5	≤ 10
	GW 500 A6	272 618	228 727	100 - 500	± 15 %		≤ 18	≤ 25

Type	Design [Ag-G3-MS9-V0-VS3]	Order number (1 piece)*	Order number (80 pieces)	Setting range [mbar]	max.	Switching difference Δp [mbar]		
						p ↓min.	p ↓max.	
GW...A6 pressure switch	GW 3 A6	231 111	–	1 - 3	± 15 %		≤ 0,7	≤ 0,8
	GW 10 A6	231 112	–	2 - 10	± 15 %		≤ 1,3	≤ 1,5
	GW 50 A6	231 113	–	5 - 50	± 15 %		≤ 2,5	≤ 3
	GW 150 A6	231 114	–	5 - 150	± 15 %		≤ 5	≤ 10
	GW 500 A6	231 115	–	100 - 500	± 15 %		≤ 18	≤ 25

\* including line socket

Type	Design [Ag-G3-MS9-V0-VS3]	Order number (1 piece)	Order number (80 pieces)	Setting range [mbar]	max.	Switching difference Δp [mbar]		
						p ↓min.	p ↓max.	
GW...A6/1 pressure switch	GW 50 A6/1	275 411	242 676	5 - 50	± 15 %		≤ 2,5	≤ 3
	GW 150 A6/1	275 412	242 677	5 - 150	± 15 %		≤ 5	≤ 10
	GW 500 A6/1	275 413	242 678	100 - 500	± 15 %		≤ 18	≤ 25

with damping nozzle 2x