

Compact pressure switch for gases and air GW A4

Pressure limiters
 ÜB A4 and NB A4 Double
 pressure switches GW A4/ GW A4

DUNGS®



Technical description

The GW A4 pressure switches, the pressure limiters ÜB A4 and NB A4 and the double pressure switch GW A4 / GW A4 are adjustable pressure switches for automatic burner controls. They are suitable for switching a circuit on, off or over on changes in actual pressure value relative to the set reference value.

The reference value (switching point) is adjusted on a setting wheel provided with a scale. Test nipple integrated in metal housing as standard.

Application

Pressure monitoring in firing, ventilation and air-conditioning systems. Suitable for gases of families 1,2,3 and other neutral gaseous media.

Approvals

EU type test approval as per EU Gas Appliance Directive. TÜV (German Technical Inspectorate) inspection for pressure switches of special construction as per TRD 604 and VdTÜV Technical Data Sheet, edition 100/1, as well as Class "S" as per EN 1854.

GW...A4	CE-0085 AO 0012
ÜB...A4	CE-0085 AO 0026
NB...A4	CE-0085 AO 0039

Approvals in other important gas-consuming countries. Special designs for the North American market with UL, FM and CSA registrations.

Functional description

Single-acting pressure switch or pressure limiter in pressure range. The pressure switches and/or pressure limiters work without using any auxiliary power.

GW A4 pressure switch

The control unit responds to pressure. If the set reference value is exceeded or undershot, the circuit is switched on, off or over.

ÜB A4, NB A4 pressure limiters

The control unit responds to pressure. Interlock is performed when the set reference value is exceeded or undershot.

The "Locked" switching state is indicated by a glow lamp.

Restart is only possible by activating the reset button on the setting wheel of the pressure limiter after the operating pressure is attained.

ÜB A4: Switches and locks when the set pressure is exceeded.

NB A4: Switches and locks when the set pressure is undershot.

Double pressure switch

GW A4 / GW A4
 Combination of two GW A4 single pressure switches flanged together. The setting of the two reference values is performed separately and independently. This permits a combination of different reference value setting ranges. The same medium and pressure are applied to the two control units.

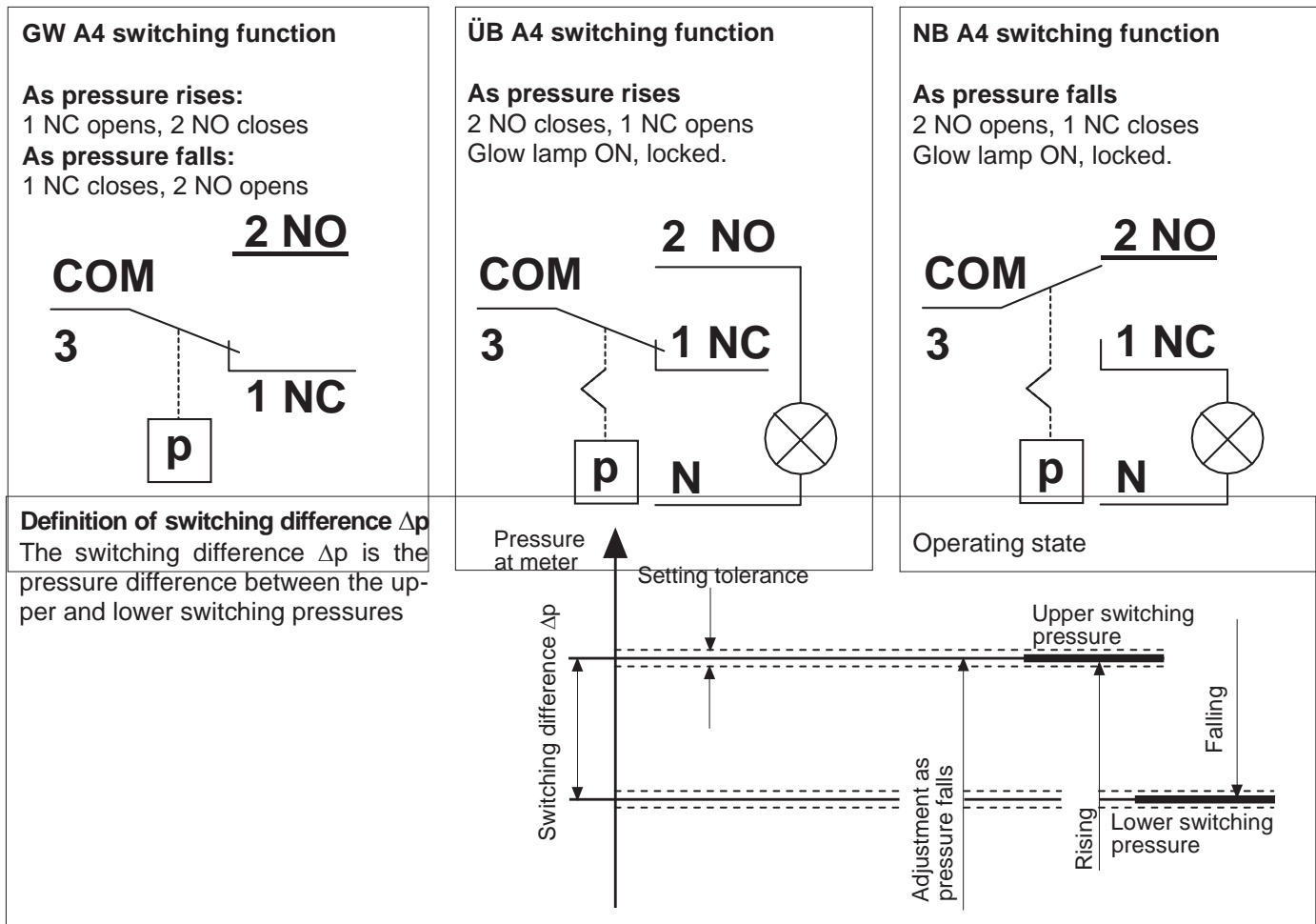

Specifications

Max. operating pressure	NB, ÜB, GW 3 A4 - GW 150 A4 NB, ÜB, GW 500 A4	500 mbar (50 kPa) 600 mbar (60 kPa)
Pressure connection	Standard: Special design:	G 1/4 female thread on centre of housing underside as per ISO 228 additionally G 1/4 female thread on opposite measuring connection side
Measuring connection	Test nipple integrated in metal housing, \varnothing 9	
Temperature range	Ambient temperature -15 °C to +60 °C Medium temperature -15 °C to +60 °C Storage temperature -30 °C to +80 °C	
Materials	Housing Switch Diaphragms Switching contact	aluminium die casting polycarbonate NBR basis Ag, fine silver, optional (Au)
Switching voltage	AC eff. min. 10 V DC min. 12 V	max. 250V max. 48 V
Nominal current	AC eff. 10 A	
Switching current	AC eff. 6 A AC eff. 3 A AC eff. min. 20 mA DC min. 20 mA DC max. 1 A	at $\cos \varphi$ 1 at $\cos \varphi$ 0,6
Electrical connection	Standard: Special design:	at screw terminals via PG* 11 cable gland (* heavy-gauge conduit thread) plug connection for line sockets as per DIN 43 650 A, 3-pin with protective contact
Degree of protection	IP 54 as per IEC 529 (EN 60529)	
Setting tolerance	\pm 15% switching point deviation referred to reference value, adjusted as pressure rises, vertical diaphragm position	

Dimensions [mm]

GW ... A4, ÜB ... A4, NB ... A4

GW ... A4 / GW ... A4

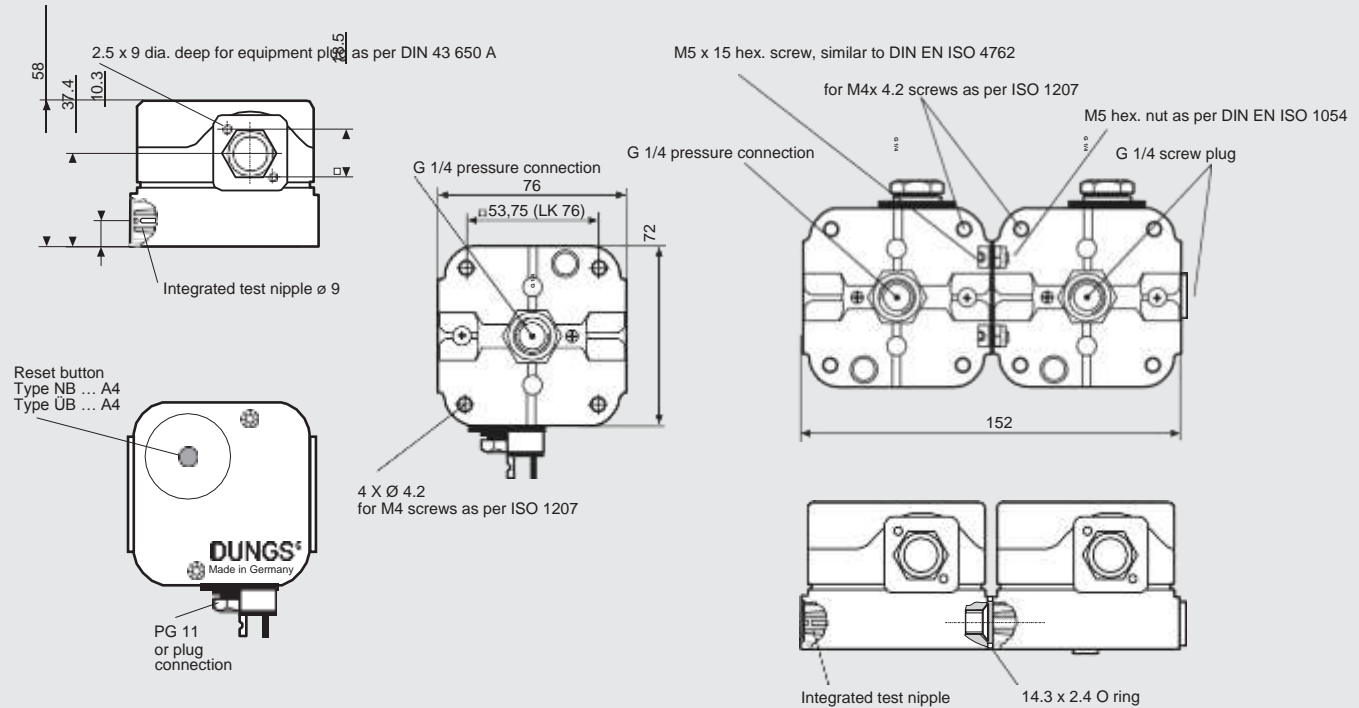

Installation position

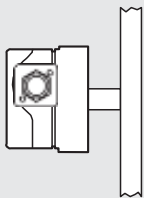

Standard installation position

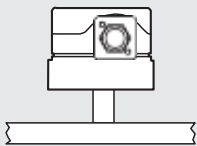

When installed horizontally, the pressure switch switches at a pressure higher by approx. 0.5 mbar.

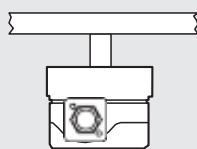

When installed horizontally overhead, the pressure switch switches at a pressure lower by approx. 0.5 mbar.

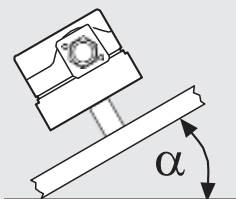

When installed in an intermediate installation position, the pressure switch switches at pressure deviating from the set reference value by max. ± 0.5 mbar.

Designation

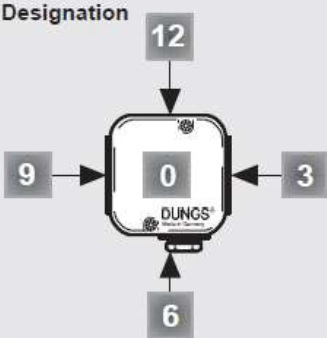

Order example

Pressure switch design
 ÜB pressure limiter
Setting range
 30 - 150 mbar
Contact material
 Ag fine silver (standard)
Electrical connection
 PG screw union
Test nipple
 MS 9
Screw plug
 At position 0
Pressure connection
 G 1/4 at position 3

GW 50 A4 [AG-PG-MS9-V0]

- Pressure connection**
 V0 Pressure connection G 1/4 Position 0
 V3 Pressure connection G 1/4 Position 3
- Screw plug**
 VS0 Screw plug at position 0
 VS3 Screw plug at position 3
- Instrument gland**
 MS3 Test nipple at position 3
 MS9 Test nipple at position 9
 M9 Test nipple, open Position 9
- Electrical connection**
 PG PG 11 cable gland
 G 3 Equipment plug, 3 pin + E
- Contact material**
 Ag Fine silver (standard)
 Au Gold-plated fine silver
- Setting ranges (mbar)**

	GW	NB	ÜB
3	0.4 - 3	X	
10	1 - 10	X	
50	2.5 - 50	X	X
150	30 - 150	X	X
500	100 - 500	X	X

- Pressure switch design**
 GW ... A4 Pressure switch switches if set reference value is exceeded or undershot.
 ÜB ... A4 Pressure limiter switches and locks if set reference value is exceeded.
 NB ... A4 Pressure limiter switches and locks if set reference value is undershot.

ÜB 150 A4 [AG-PG-MS9-VS0-V3]

Accessories for pressure switches GW A4, NB A4, ÜB A4	Order No.
Kit: G3 equipment plug, 3-pin + E, GW...A	219 659
Kit: G3 equipment plug, 3-pin + E, NB.../ÜB...A	227 644
Kit: G2 equipment plug, 2-pin + E	219 660
Glow lamp and series resistor (50 x) 220 V AC (spare part requirement NB, ÜB)	231 776
Glow lamp and series resistor (50 x) 120 V AC (spare part requirement NB, ÜB)	231 768
Pilot lamp 24 V AC/DC (50 x)	231 771
Line sockets, 3-pin + E grey GDMW	210 318
Line sockets, 2-pin + E grey GDMW	210 317
G 1/4 test nipple and seal ring	230 398
G 1/4 screw plug and seal ring	230 396
Double pressure switch mounting kit	213 910
Metal mounting bracket	230 288





Compact pressure switch
For gases and air
GW A4
Pressure limiter
ÜB A4 and NB A4
Double pressure switch
 GW A4 / GW A4

DUNGS®

Technical data

1 mbar = 100 Pa = 0.1 kPa ≈ 10 mm WS

1 Pa = 0.01 mbar ≈ 0.1 mm WS

Type	Version	Order No. (PG 11)	Setting range [mbar]		Switching difference Δp [mbar]		
GW A4 pressure switch	GW 3 A4	172 680	0.4 - 3		≤ 0.3		
	GW 10 A4	172 690	1 - 10		≤ 0.5		
	GW 50 A4	153 600	2.5 - 50		≤ 1		
	GW 150 A4	157 050	30 - 150		≤ 3		
	GW 500 A4	157 060	100 - 500		≤ 10		
ÜB A4 pressure limiter	ÜB 50 A4	210 537	2.5 - 50		--		
	ÜB 150 A4	138 630	30 - 150		--		
	ÜB 500 A4	210 970	100 - 500		--		
NB A4 pressure limiter	NB 50 A4	210 534	2.5 - 50		--		
	NB 150 A4	210 931	30 - 150		--		
	NB 500 A4	210 971	100 - 500		--		
GW A4 min. / GW A4 max. Double pressure switch	GW 3 / 3 A4	208 929	0.4 - 3		≤ 0.3	≤ 0.3	
	GW 3 / 10 A4	208 930	0.4 - 3		1 - 10	≤ 0.3	≤ 0.5
	GW 10 / 10 A4	208 931	1 - 10			≤ 0.5	≤ 0.5
	GW 10 / 50 A4	208 932	1 - 10		2.5 - 50	≤ 0.5	≤ 1
	GW 10 / 150 A4	208 933	1 - 10		30 - 150	≤ 0.5	≤ 3
	GW 50 / 50 A4	208 934	2.5 - 50			≤ 1	≤ 1
	GW 50 / 150 A4	208 935	2.5 - 50		30 - 150	≤ 1	≤ 3
	GW 150 / 150 A4	208 936	30 - 150			≤ 3	≤ 3
GW 500 / 500 A4	208 937	100 - 500		≤ 10	≤ 10		



**Betriebs- und Montagean-
leitung**

**Operation and assembly
instructions**

**Noticed'emploi et demon-
tage**

**Istruzioni di esercizio di
montaggio**

Differenzdruckwächter für Luft,
Rauch- und Abgase
GGW ... A4
Doppeldruckwächter
GGW ... A4/GGW ... A4

Differential pressure switch for
air, flue and exhaust gases
GGW ... A4
Double pressure switch
GGW ... A4/GGW ... A4

Pressostat différentiel pour air,
fumée et gaz brûlés
GGW ... A4
Pressostat double
GGW ... A4/GGW ... A4

Pressostato differenziale per
aria, gas di combustione e di
scarico
LGW ... A4
Pressostato doppio
LGW ... A4/LGW ... A4

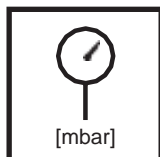

Max. Betriebsdruck
Max. operating pressure
Pression de service maxi.
Max. pressione di esercizio
 $p_{max.} = 500 \text{ mbar}$

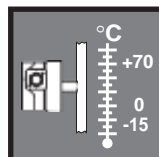

Umgebungstemperatur
Ambient temperature
Température ambiante
Temperatura ambiente
-15 °C ... +70 °C

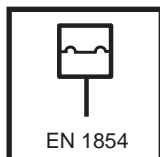

**Druckwächter/ Pressure Switch/
Pressostat/ Pressostato**
Typ/Type/Type/Tipo
GGW...A4, GGW...A4/2
nach / acc. / selon / a norme
DIN EN 1854

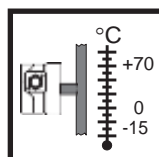

Mediumstemperatur
Medium temperature
Température du fluide
Temperatura fluido
-15 °C ... +70 °C

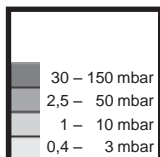

Einstellbereiche
Setting ranges
Plages de réglage
Campi di taratura

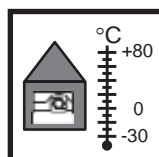

Lagertemperatur
Storage temperature
Température de stockage
Temperatura stoccaggio
-30 °C ... +80 °C

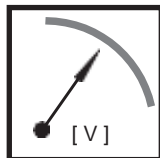

~(AC) eff., min./mini 24 V,
~(AC) max. /maxi. 250 V
=(DC) min./mini. 24 V,
=(DC) max. /maxi. 48 V

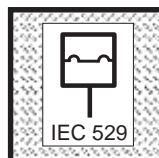

Schutzart / Degree of protection
Protection / Protezione
GGW...A4
IP 54 nach / acc. / selon / a norme
IEC 529 (EN 60529)
GGW...A4/2
IP 65 nach / acc. / selon / a norme
IEC 529 (EN 60529)

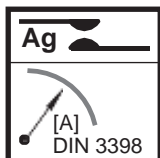

**Nennstrom/nominal current/courant
nominal/corrente nominale ~(AC) 10 A**
**Schaltstrom/current on contact/courant
de commutation/corrente di intervento**
~(AC) eff., min./mini 20 mA,
~(AC) max./maxi. 6 A $\cos \varphi = 1$
~(AC) max./maxi. 3 A $\cos \varphi = 0,6$
=(DC) min./mini. 20 mA
=(DC) max./maxi. 1 A

Einbaulage / Installation position / Position de montage / Posizione de montaggio	
	Standard einbaulage Standard installation position Position de montage standard Posizione standard
	Bei waagrechtem Einbau schaltet der Druckwächter bei einem um ca. 0,5 mbar höheren Druck. In the horizontal installation position the switching pressure is increased by approx. 0.5 mbar. Monté horizontalement, le pressostat commute à une pression d'environ 0,5 mbar plus élevée. Con montaggio orizzontale il pressostato scatta ad pressione superiore di circa 0,5 mbar.
	Bei Einbau waagrecht über Kopf schaltet der Druckwächter bei einem um ca. 0,5 mbar niedrigerem Druck. When the pressure switch is mounted horizontally overhead, its switching pressure decreases by approx. 0.5 mbar. Monté horizontalement à l'envers, le pressostat commute à une pression d'environ 0,5 mbar moins élevée. Con montaggio orizzontale capovolto il pressostato scatta ad una pressione inferiore di circa 0,5 mbar.
	Bei Einbau in einer Zwischeneinbaulage schaltet der Druckwächter bei einem vom eingestellten Sollwert maximal $\pm 0,5 \text{ mbar}$ abweichenden Druck. When the pressure switch is mounted in an intermediate position, its switching pressure deviates by max. $\pm 0.5 \text{ mbar}$ from the setpoint. Monté dans une position intermédiaire, le pressostat commute à une pression d'un maximum de $\pm 0,5 \text{ mbar}$ par rapport à la valeur de consigne réglée. Con il montaggio in una posizione intermedia il pressostato scatta ad una pressione diversa da quella nominale di max. $\pm 0,5 \text{ mbar}$.

Einbaumaße / Dimensions / Cotes d'encombrement / Dimensioni [mm]

GGW...A4, IP 54

Ø 2,5 x 9 tief für Gerätestecker DIN 43 650 A
 2.5 x 9 dia. deep for DIN 43 650 A equipment plug
 Ø 2,5 x 9 de profond pour embasade connecteur DIN 43 650 A
 foro per spina Ø 2.5 x 9 DIN 43 650 A

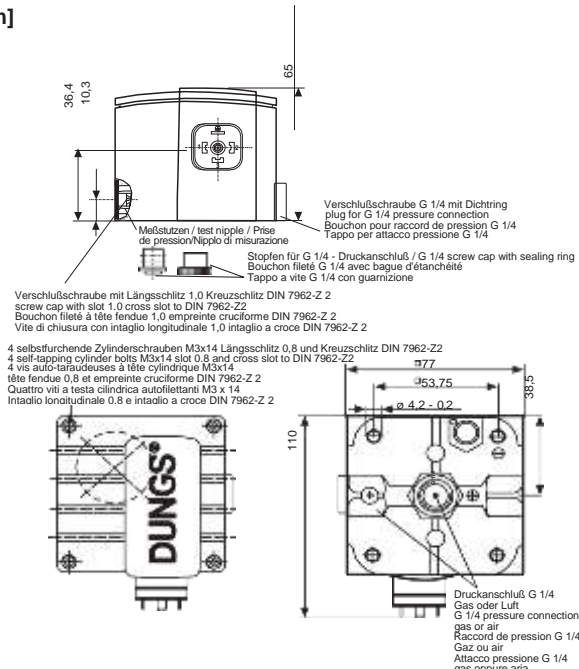
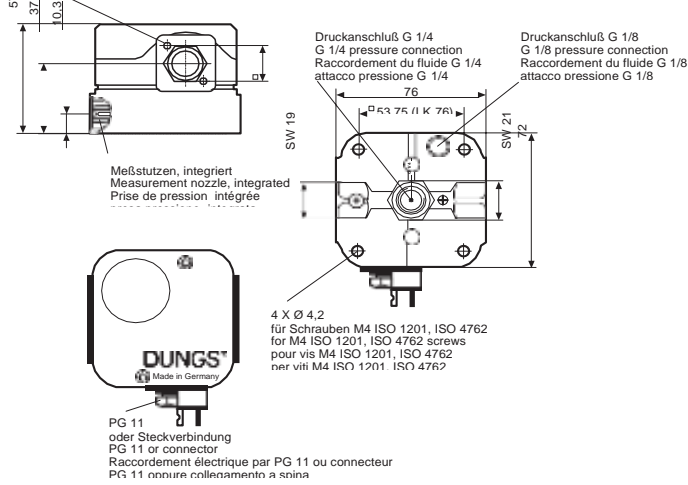

Einbaumaße / Dimensions / Cotes d'encombrement / Dimensioni [mm]
GGW ... A4 / GGW ... A4, IP 54

Innensechskantschraube M5 x 12, ähnlich ISO 4762
 M5 x 12 socket head screw, similar to ISO 4762
 Vis à six pans creux M5 x 12, similaire à ISO 4762
 Vite esagonale interna M5 x 12, simile ISO 4762

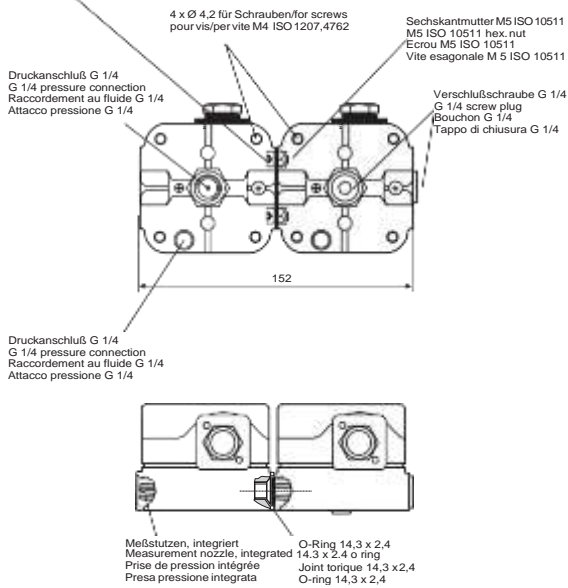

**Zusammenbauset Doppeldruckwächter
 Double pressure switch: Side-By-Side Mounting Kit
 Kit de montage pour pressostat double
 Set di montaggio per il pressostato doppio
 GGW ... A4 / GGW ... A4, IP 54**

Bestell-Nr.
 Order-No.
 Réf. de commande
 Nr. codice
213 910

O-Ring Ø 14,3 x 2,4
 O ring Ø 14.3 x 2.4
 Joint torique Ø 14,3 x 2,4
 O-Ring Ø 14,3 x 2,4

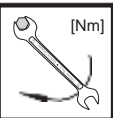
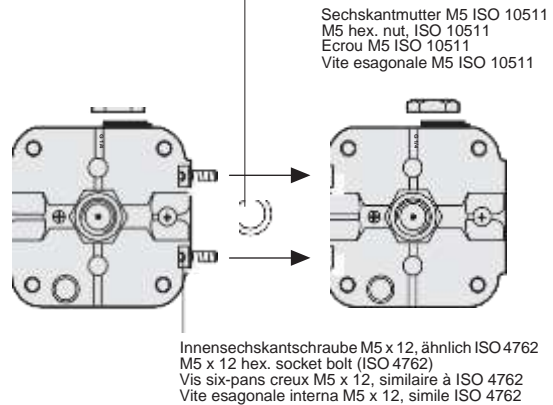

**max. Drehmomente / Systemzubehör
 max. torque / System accessories
 max. couple / Accessoires du système
 max. coppie / Accessorio di sistema**

M 4 G 1/4
2,5 Nm 7 Nm

**Drehmoment Haubenschraube
 max. torque cap-head screw
 Couple max. pour les vis du couvercle
 Coppia max. per vite a cappuccio** **1,2 Nm**



**Geeignetes Werkzeug einsetzen!
 Please use proper tools!
 Utiliser des outils adaptés!
 Impiegare gli attrezzi adeguati!**



**Gerät darf nicht als Hebel be-
 nutzt werden
 Do not use unit as lever.
 Ne pas utiliser le pressostat
 comme un levier.
 L'apparecchio non deve essere
 usato come leva.**

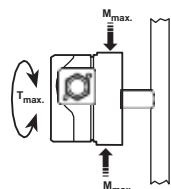

DN	6	8	
Rp	1/8	1/4	
M _{max.}	25	35	[Nm] t ≤ 10 s
T _{max.}	15	20	[Nm] t ≤ 10 s

**Einbau
GGW...A4**

1. Der Druckwächter wird direkt auf einen Rohrstutzen mit R 1/4 Außengewinde aufgeschraubt. Bild 1.
2. Nach Einbau Dichtheits- und Funktionskontrolle durchführen.

⚠ Auf vibrationsfreien Einbau achten! Bild 2.

**Installation of
GGW...A4**

1. Screw the pressure switch directly on a tube socket with R 1/4 outer thread (see Fig. 1).
2. After installation, perform a leakage and function test.

⚠ Ensure that the pressure switch is installed free of vibration (see Fig. 2).

**Montage
GGW...A4**

1. Le pressostat peut se visser directement sur un piquage R 1/4 Fig.1.
2. Après le montage contrôler la jonction et l'étanchéité.

⚠ Veiller à ce que l'appareil ne subisse pas de vibrations ! Fig. 2.

**Montaggio
GGW...A4**

1. Il pressostato viene avvitato direttamente su un tubo di sostegno con filetto esterno R 1/4 (Fig.1)
2. Dopo il montaggio effettuare i controlli di tenuta e funzionalità.

⚠ Evitare possibilità di vibrazioni! Fig 2.

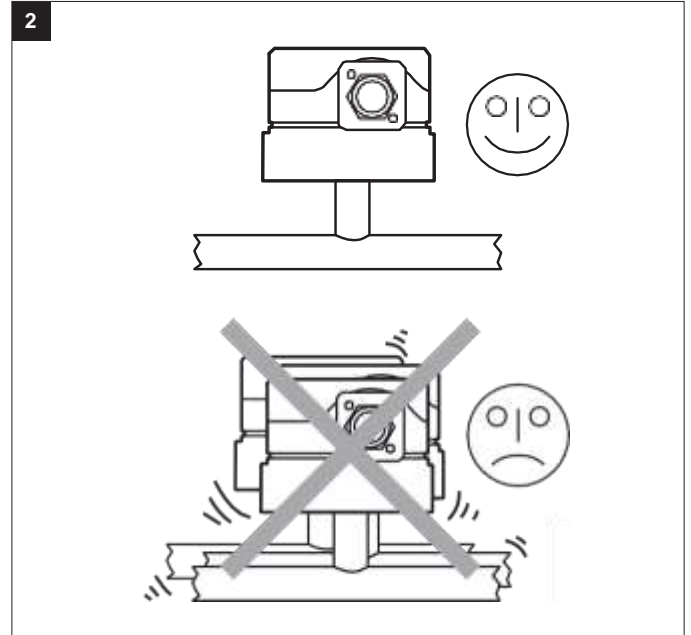
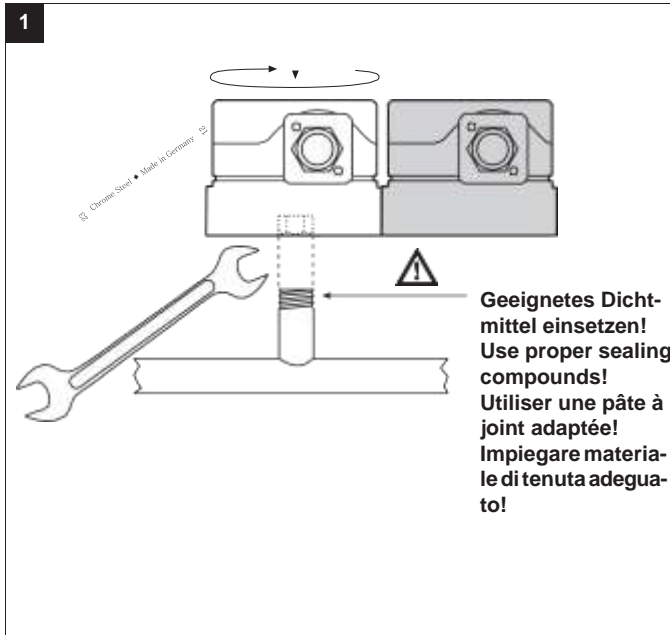

Elektrischer Anschluß
Electrical connection
Raccordement électrique
Allacciamento elettrico
IEC 730-1 (VDE 0631 T1)

PG 11

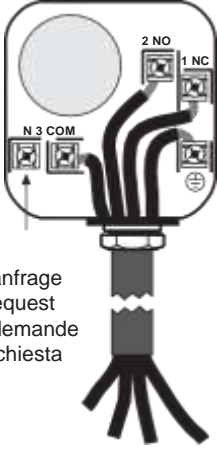

N
 auf anfrage
 on request
 sur demande
 su richiesta

DIN 43 650 A

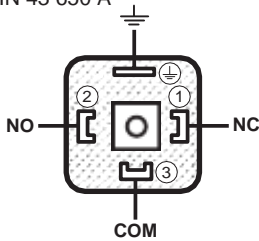

⚠ Erdung nach örtlichen Vorschriften.
 Grounding acc. local regulations.
 Mise à la terre selon normes locales.
 Messa a terra secondo prescrizioni locali.

Zur Erhöhung der Schaltleistung wird bei DC-Anwendungen < 20 mA und 24 V der Einsatz eines RC-Gliedes empfohlen.

To increase the switching capacity, we recommend that you use a RC device for current values < 20 mA and 24 V d.c. applicatins.

Pour augmenter la puissance de rupture, l'utilisation d'un circuit RC est préconisée pour les applications à courant continu < 20 mA et 24 V.

Per aumentare la potenza d'inserimento con applicazioni DC < 20 mA e 24 V, consigliamo l'impiego di un elemento RC.

Schaltfunktion
Switching function
Schéma de fonctionnement
Funzione di commutazione
pressostato

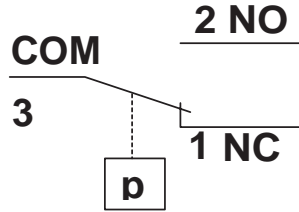

Bei steigendem Druck:
 1 NC öffnet, 2 NO schließt. Bei fallendem Druck:
 1 NC schließt, 2 NO öffnet.

While pressure is increasing:
 1 NC opens, 2 NO closes. While pressure is decreasing: 1 NC closes, 2 NO opens.

Pression montante:
 1 NC ouvre, 2 NO ferme. Pression descendante: 1 NC ferme, 2 NO ouvre

Con pressione in salita: 1 NC apre, 2 NO chiude. Con pressione in discesa: 1 NC

Druckanschluß
Pressure port
Prise de pression
Attacco pressione

- | | |
|-----------------------------------------------|-----------------------------------------------|
| 1 Druckanschluß G 1/4 (+) für Gas und Luft | 2 Druckanschluß G 1/8 (-) für Gas und Luft |
| 1 Pressure port G 1/4 (+) for gas and air | 2 Pressure port G 1/8 (-) for gas and air |
| 1 Prise de pression G 1/4 (+) pour gaz et air | 2 Prise de pression G 1/8 (-) pour gaz et air |
| 1 Attacco pressione G 1/4 (+) per gas ed aria | 2 Attacco pressione G 1/8 (-) per gas ed aria |

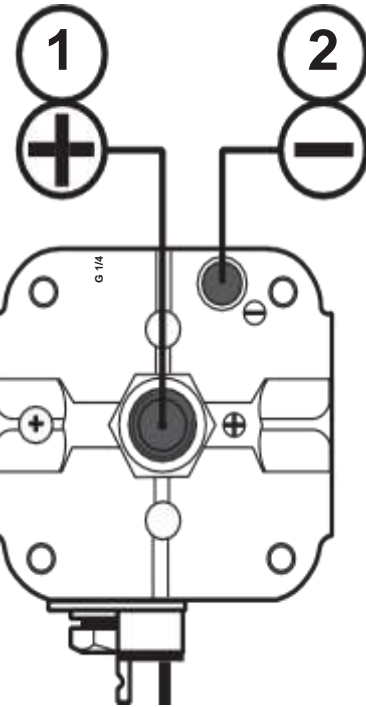
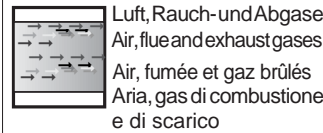
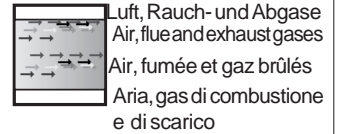

Einstellung des Druckwächters

Haube mit geeignetem Werkzeug demontieren, Schraubendreher No. 3 bzw. PZ 2, Bild 1. Haube abnehmen.

⚠ Berührungsschutz ist nicht grundsätzlich gewährt, Kontakt mit spannungsführenden Teilen möglich.

Setting the pressure switch

Dismount the hood using a suitable tool, e.g. screwdriver no. 3 or PH1, Fig. 1. Remove hood.

⚠ There is no protection against accidental contact. Contact with live parts is possible.

Einstellung GGW ... A4

Druckwächter am Einstellrad mit Skala auf vorgeschriebenen Drucksollwert einstellen, Bild 2.

Anleitung des Brennerherstellers beachten!

Druckwächter schaltet bei steigendem Druck: Einstellung auf die linke Begrenzungslinie ↑
 Druckwächter schaltet bei fallendem Druck: Einstellung auf die rechte Begrenzungslinie ↓.
 Haube wieder aufsetzen!

Setting GGW ... A4

Set the pressure switch at the setting wheel to the specified pressure setpoint using the scale, Fig. 2.

Follow the instructions of the burner manufacturer!

Pressure switch switches as pressure increases: Set to left limit line ↑
 Pressure switch switches as pressure reduces: Set to right limit line ↓.
 Remount hood!

Réglage des pressostats

Enlever les vis du capot en utilisant un tournevis N°3. PZ 2, Fig 1. Enlever le capot.

⚠ La protection n'est pas garantie, contact avec des pièces sous tension possible.

Regolazione del pressostato per

Smontare la calotta con un attrezzo adeguato, ossia cacciavite nr. 3 - rispettiv, PZ 2, figura 1
 Togliere la calotta.

⚠ Non é sostanzialmente garantita la protezione da scariche, é possibile il contatto con conduttori di tensione.

Réglage de GGW ... A4

Régler le pressostat avec son bouton gradué à la valeur désirée Fig. 2.

Respecter les recommandations du constructeur du brûleur!

Le pressostat commute par pression montante: régler sur la ligne de limitation gauche ↑
 Le pressostat commute par pression descendante: régler sur la ligne de limitation droite ↓. Remonter le capot!

Regolazione GGW ... A4

Tarare il pressostato, come in figura 2, sul valore di pressione nominale prescritto, agendo sulla rotella della scala graduata

Prestare attenzione alle prescrizioni del produttore del bruciatore!

Il pressostato scatta con pressione in salita: regolazione sulla linea di delimitazione sinistra ↑
 Il pressostato scatta con pressione in discesa: regolazione sulla linea di delimitazione destra ↓. Rimontare la calotta!

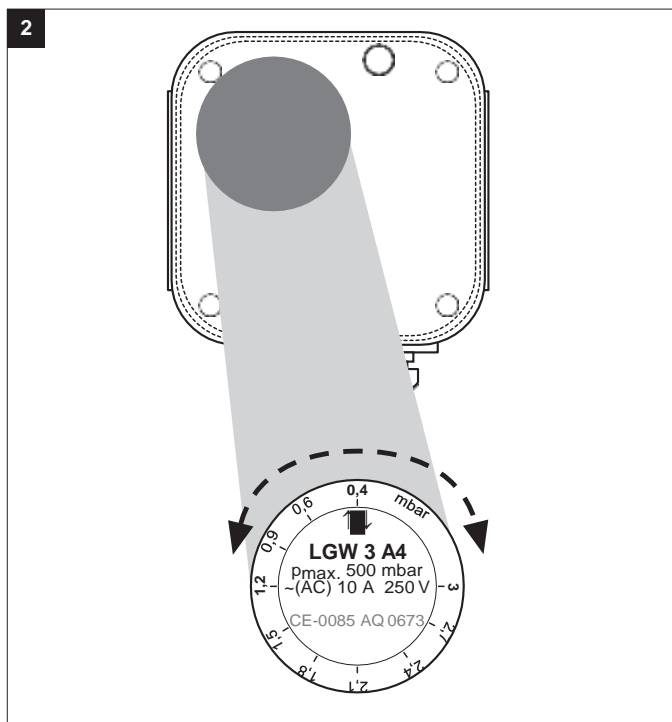
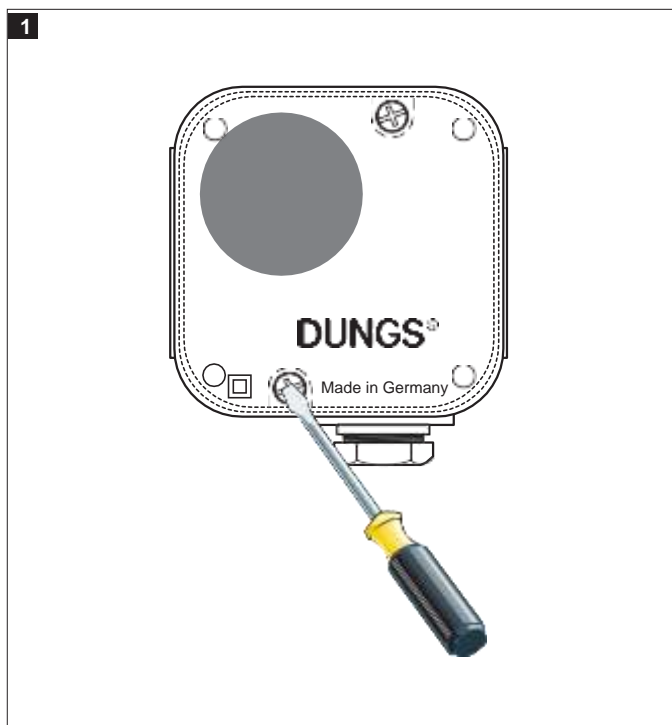



บริษัท เอดีดี เฟอร์เนส จำกัด
Add Furnace Co.,Ltd.

44 ซ.บรมราชชนนี 70 ถ.บรมราชชนนี ศาลาธรรมสพน์ ทวีวัฒนา กทม. 10170.
website: <https://www.add-furnace.com/> โทร: 02-888-3472
Line ID: @add11 e-mail: add028883472@gmail.com

Ersatzteile / Zubehör Spare parts / Accessories Pièces de rechange / access. Parti di ricambio / Accessori	Bestell-Nummer Ordering No. No. de commande Codice articolo
Haube komplett / IP 54 Hood kit, IP 54 Kit couvercle, IP 54 Set calotta, IP 54	230 275
Verschlußschraube G 1/4 mit Dichtring Screw plug Rp 1/4 with sealing ring Bouchon G 1/4 avec joint Tappo a vite G 1/4 con anello di tenuta	230 396

Ersatzteile / Zubehör Spare parts / Accessories Pièces de rechange / access. Parti di ricambio / Accessori	Bestell-Nummer Ordering No. No. de commande Codice articolo
Zusammenbauset Doppel- druckwächter, IP 54 Double pressure switch: Side- By-Side Mounting Kit, IP 54 Kit de montage pour pressostat double, IP 54 Set di montaggio per il presso- stato doppio, IP 54	213 910
Leitungsdose 3 pol. + E grau, GDMW Power socket, 3-pole + E grey, GDMW Connecteur gris 3 pôles + terre Presa di corrente a 3 poli + terra, grigia, GDMW	210 318



Arbeiten am Druckwächter dürfen nur von Fachpersonal durchgeführt werden.

Work on the pressure switch may only be performed by specialist staff.

Seul du personnel spécialisé peut effectuer des travaux sur le pressostat.

Qualsiasi operazione effettuata sul pressostato deve essere fatta da parte di personale competente.



Kondensat darf nicht in das Gerät gelangen. Bei Minustemperaturen, durch Vereisung Fehlfunktion/Ausfall möglich.

Do not allow condensate to flow into the equipment. In case of sub-zero temperatures, malfunction or equipment failure may be possible due to icing.

Eviter l'entrée de condensat dans le pressostat, une prise en glace par température négative nuirait à son fonctionnement.

nell' apparecchio non deve infiltrarsi alcuna condensa. Alle temperature negative sarebbero possibili disfunzioni dovute a formazione di ghiaccio.

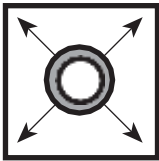

Rohrleitungsdichtheitsprüfung: Kugelhahn vor dem Druckwächter schließen.

Pipeline leakage test: close ball valve upstream of the pressure switch.

Contrôle de l'étanchéité de la conduite: fermer le robinet à boisseau sphérique *avant* le pressostat.

Per la prova di tenuta delle tubature: chiudere il rubinetto a sfera *davanti* al pressostato.



Nach Abschluß von Arbeiten am Druckwächter: Dichtheitskontrolle und Funktionskontrolle durchführen.

On completion of work on the pressure switch, perform a leakage and function test.

Une fois les travaux sur le pressostat terminés, procéder toujours à un contrôle d'étanchéité et de fonctionnement.

Al termine dei lavori effettuati su un pressostato: predisporre un controllo sia della tenuta che del funzionamento.

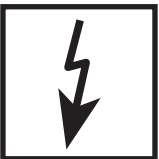

Niemals Arbeiten durchführen, wenn Gasdruck oder Spannung anliegt. Offenes Feuer vermeiden. Örtliche Vorschriften beachten.

Never perform work if gas pressure or power is applied. No naked flame. Observe local regulations.

Ne jamais effectuer des travaux sous pression et ou sous tension. Eviter toute flamme ouverte. Observer les réglementations.

In nessun caso si debbono effettuare lavori in presenza di pressione gas o di tensione elettrica. Evitare i fuochi aperti e osservare le prescrizioni di sicurezza locali.



Bei Nichtbeachtung der Hinweise sind Personen- oder Sachfolgeschäden denkbar.

If these instructions are not heeded, the result may be personal injury or damage to property.

En cas de non-respect de ces instructions, des dommages corporels ou matériels sont possible.

La non osservanza di quanto suddetto può implicare danni a persone o cose.