

RevNo	Revision note	Date	Signature	Checked
-------	---------------	------	-----------	---------

DIMENSION - UNIT : mm

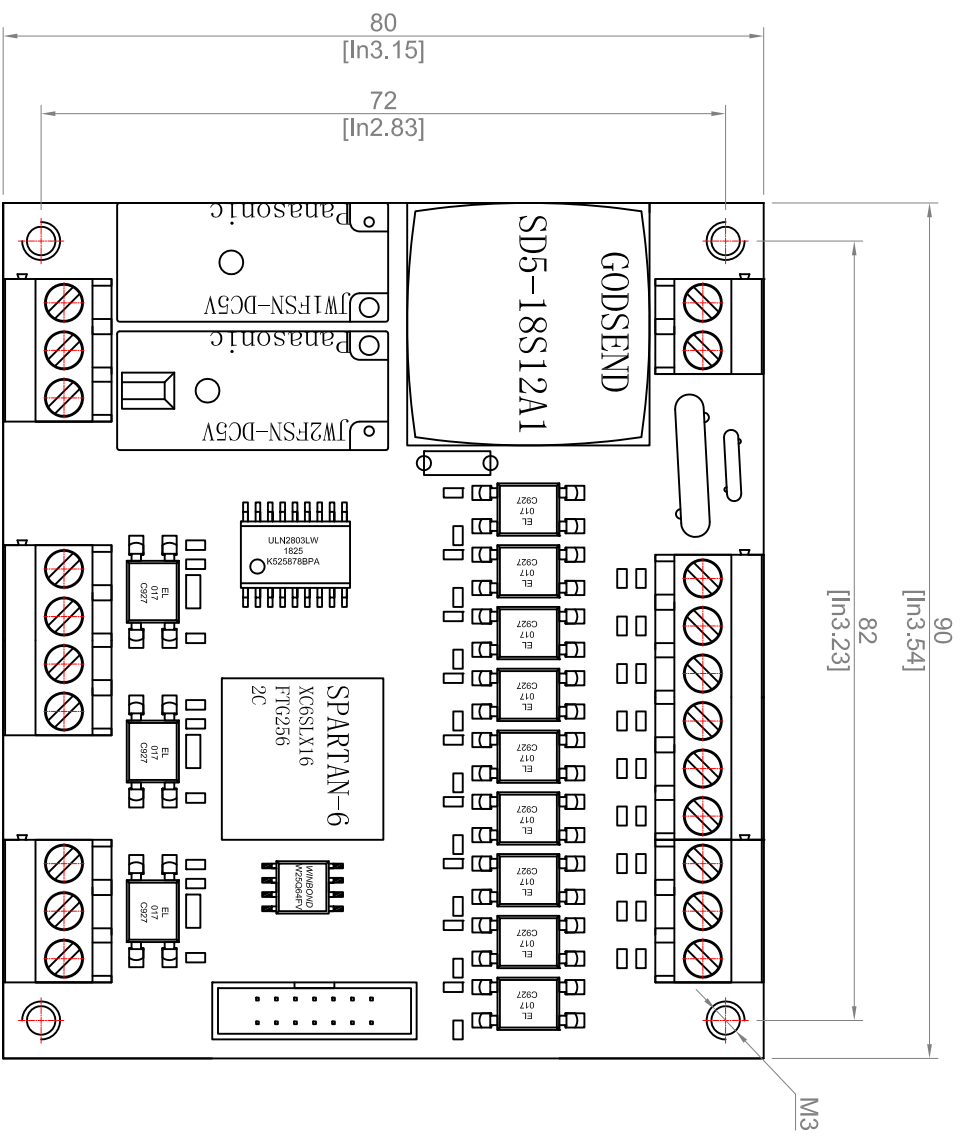

1 2 3 4

A B C D E F

1 2 3 4

A B C D E F

SERVED THE RIGHT OF THIS DRAWING BY ADD FURNACE CO.,LTD.  
DO NOT COPY OR REPEAT THIS DRAWING BEFORE GETTING CONSENT FROM COMPANY

Itemref	Quantity	Title/Name, designation, material, dimension etc	Article No./Reference
---------	----------	--	-----------------------

Designed by	Checked by	Approved by - date	File name
XIE	HAI_BY	FENG_BY_01/01/19	BOARD-DIMENSION

CUSTOMER	Edition	Sheet	TITLE
1-X	0	1/1	GAS-LEAK-DETECTOR-SMART-BOARD-6-CHANNEL

บริษัท เอดด์ เฟอร์เนซ จำกัด  
ADD FURNACE CO.,LTD.  
https://www.add-furnace.com sales@add-furnace.com  
Tel:02-888-3472 Fax:02-888-3258



AC 220V  
L1 N

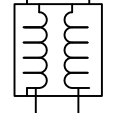
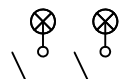

Transformer DC 12V 54W  
HDR-60-12

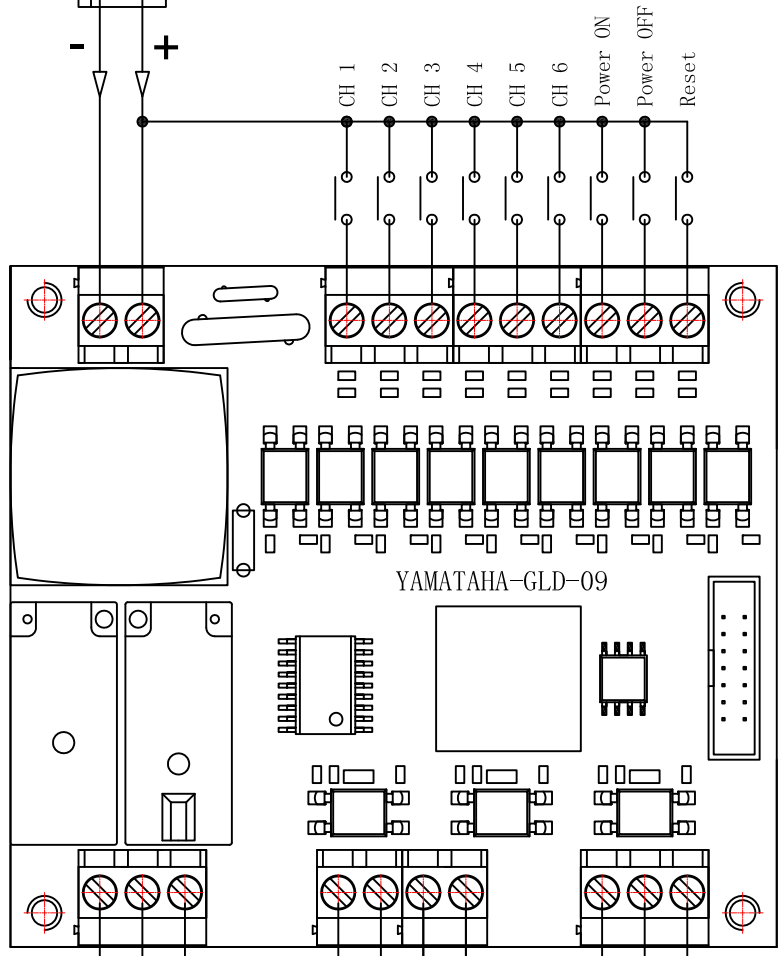

Non-Voltage Contact  
for Alarm or Solenoid Valve

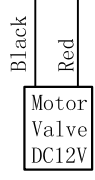

Motor Valve  
DC12V

Gas Leak Detector  
Power Supply

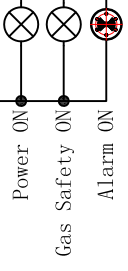

Itemref	Quantity	Title/Name, designation, material, dimension etc	Article No./Reference	
Designed by XIE	Checked by HAI	Approved by - date FENG-01/01/19	File name WIRING-LAYOUT	TITLE GAS-LEAK-DETECTOR-SMART-BOARD-6-CHANEL
CUSTOMER		xxx		
Scale(A4) 1:x	Edition 0	Sheet 1/1	View(Third)	

SERVED THE RIGHT OF THIS DRAWING BY  
ADD FURNACE CO.,LTD. DO NOT COPY OR REPEAT THIS  
DRAWING BEFORE GETTING CONSENT FROM COMPANY



**บริษัท เอ็ดดี เฟอร์เนส จำกัด**  
**ADD FURNACE CO.,LTD.**  
https://www.add-furnace.com sales@add-furnace.com  
Tel:02-888-3472 Fax:02-888-3258

1 2 3 4

A

A

280  
[11.02in]

B

B

C

C

350  
[13.78in]

D

D

E

E

F

F

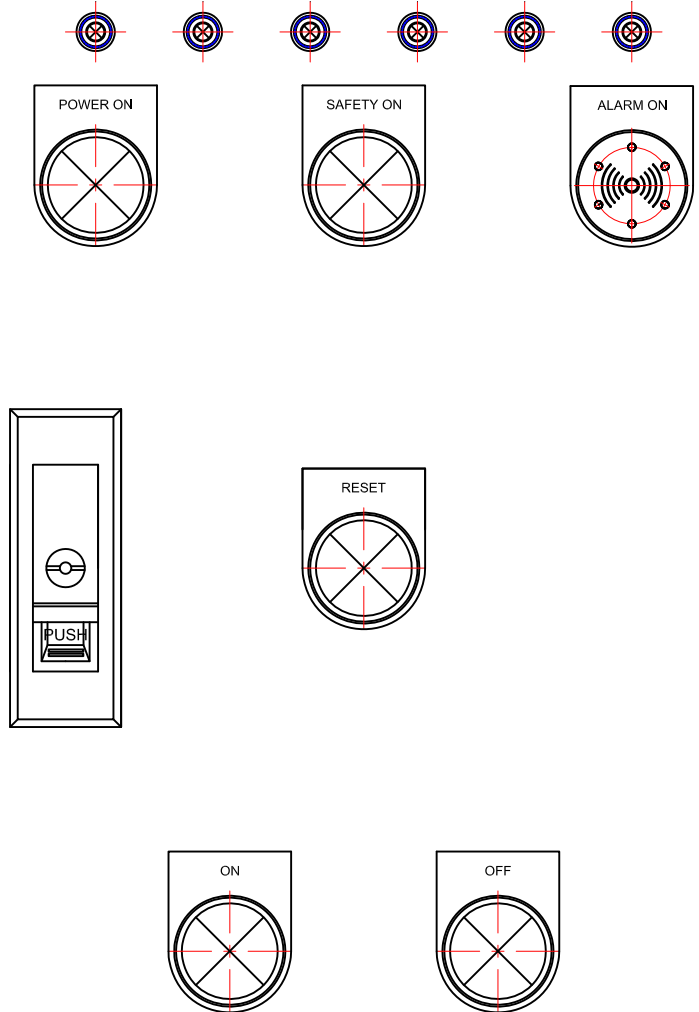

Itemref	Quantity	Title/Name, designation, material, dimension etc			Article No./Reference
		Checked by HAI	Approved by - date FENG-01/01/19	File name DRAWING	TITLE 6POINT-GAS-DECTOR-CONTROL-LAYOUT
		CUSTOMER	xxx		
		Scale(A4) 1:x	Edition 0	Sheet 1/1	View(Third) 



**บริษัท เอดีดี เฟอร์เนส จำกัด**  
**ADD FURNACE CO.,LTD.**  
<https://www.add-furnace.com> [sales@add-furnace.com](mailto:sales@add-furnace.com)  
 Tel:02-888-3472 Fax:02-888-3258

1 4

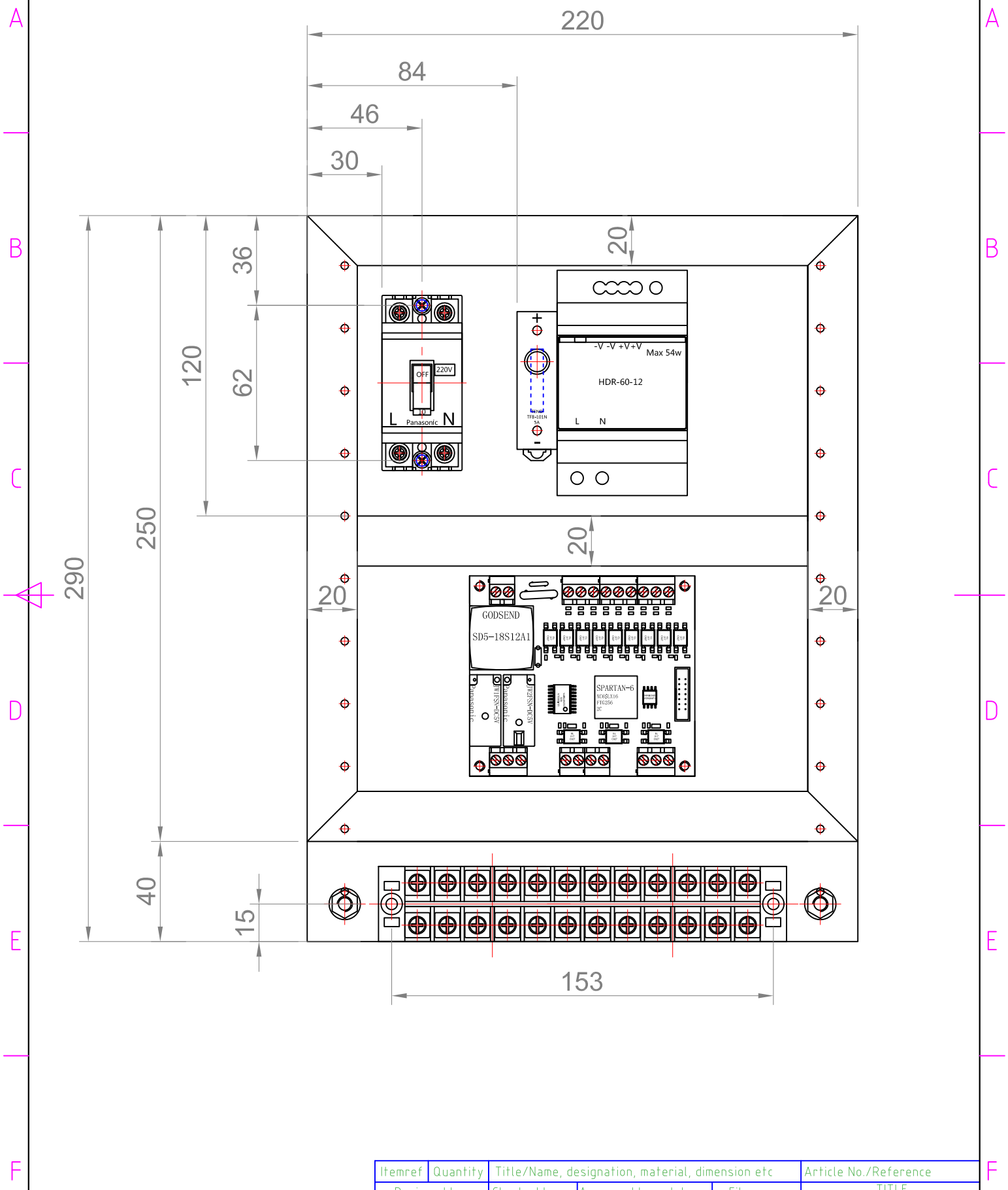

Itemref	Quantity	Title/Name, designation, material, dimension etc	Article No./Reference		
Designed by XIE	Checked by HAI	Approved by - date FENG-01/01/19	File name DRAWING	TITLE 6POINT-GAS-DECTOR-CONTROL-LAYOUT	

SERVED THE RIGHT OF THIS DRAWING BY  
 ADD FURNACE CO.,LTD. DO NOT COPY OR REPEAT THIS  
 DRAWING BEFORE GETTING CONSENT FROM COMPANY



**บริษัท เอดิต เฟอร์เนส จำกัด**  
**ADD FURNACE CO.,LTD.**  
<https://www.add-furnace.com> sales@add-furnace.com  
 Tel:02-888-3472 Fax:02-888-3258

CUSTOMER xxx	Edition 0	Sheet 1/1	View(Third)
Scale(A4) 1:x			

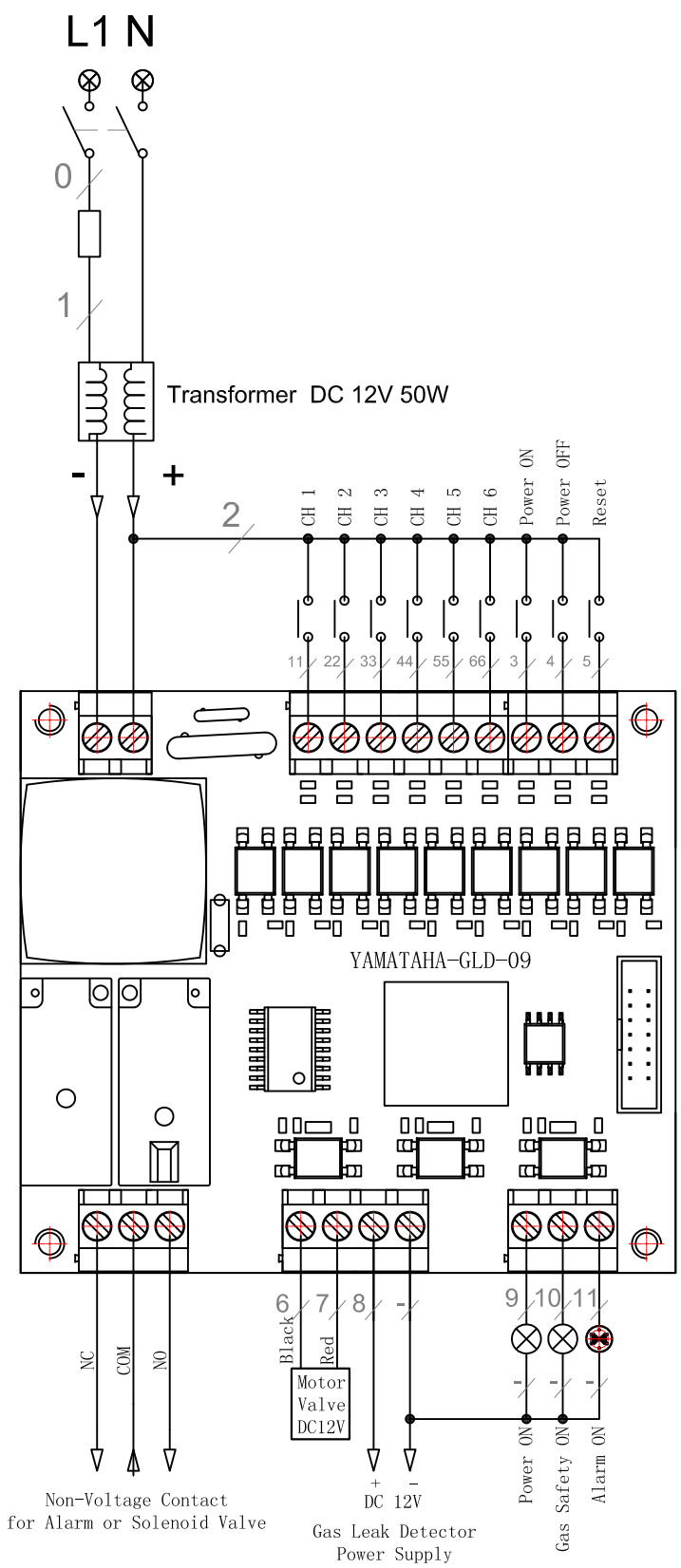

Itemref	Quantity	Title/Name, designation, material, dimension etc	Article No./Reference
Designed by XIE	Checked by HAI	Approved by - date FENG-01/01/19	File name DRAWING
TITLE			6POINT-GAS-DECTOR-CONTROL-LAYOUT

SERVED THE RIGHT OF THIS DRAWING BY  
ADD FURNACE CO.,LTD. DO NOT COPY OR REPEAT THIS  
DRAWING BEFORE GETTING CONSENT FROM COMPANY



**บริษัท เอดิต เฟอ์เนส จำกัด**  
**ADD FURNACE CO.,LTD.**  
https://www.add-furnace.com sales@add-furnace.com  
Tel:02-888-3472 Fax:02-888-3258

CUSTOMER	xxx		
Scale(A4)	Edition	Sheet	View(Third)
1:x	0	1/1	

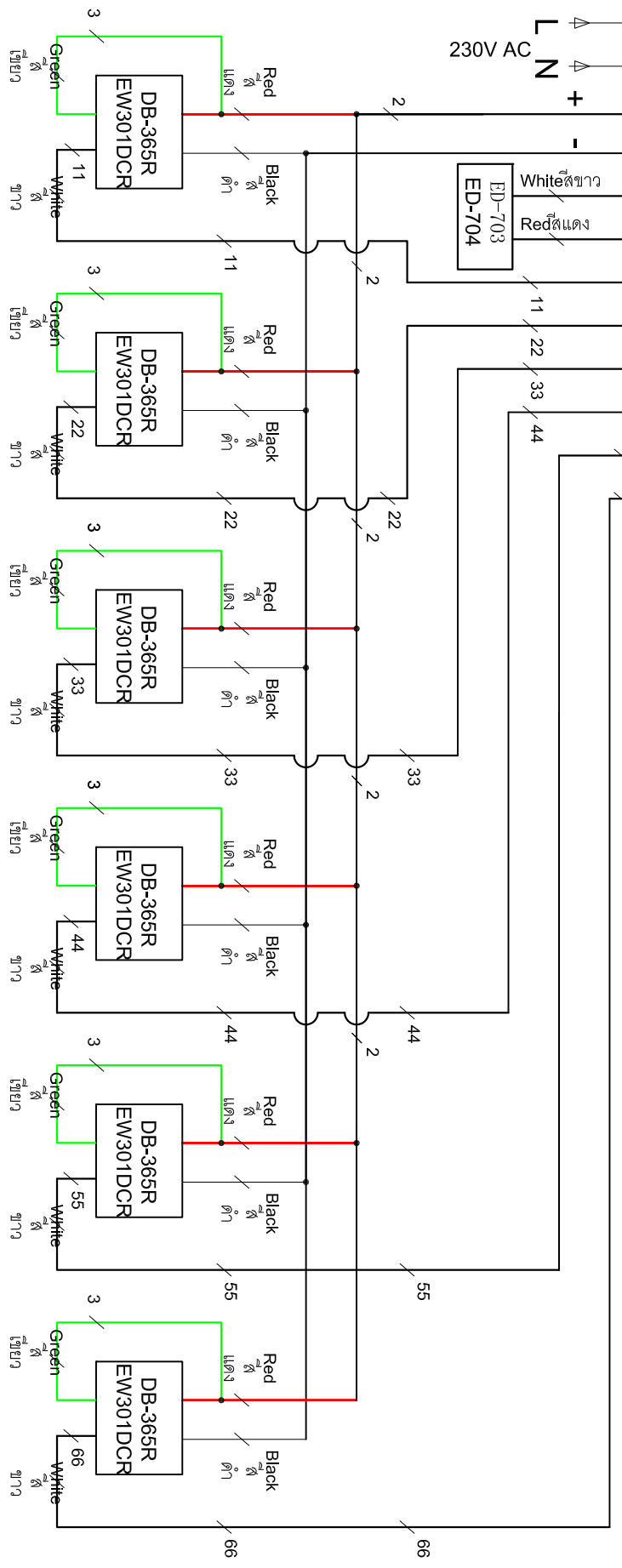
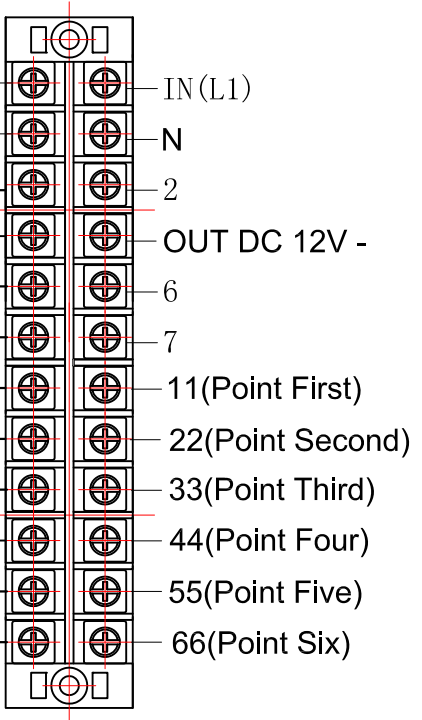

RevNo	Revision note	Date	Signature	Checked
-------	---------------	------	-----------	---------

Itemref	Quantity	Title/Name, designation, material, dimension etc	Article No./Reference
---------	----------	--	-----------------------

Designed by	Checked by	Approved by - date	File name
XIE	HAI_BY	FENG_BY_01/01/19	WIRING-LAYOUT

**บริษัท เอดด์ เฟอร์เนซ จำกัด**  
**ADD FURNACE CO.,LTD.**  
<https://www.add-furnace.com> sales@add-furnace.com  
 TEL:02-888-3472 Fax:02-888-3258

Scale(A4)	Edition	Sheet	View
1:X	0	1/1	View

SERVED THE RIGHT OF THIS DRAWING BY ADD FURNACE CO.,LTD.  
 DO NOT COPY OR REPEAT THIS DRAWING BEFORE GETTING CONSENT FROM COMPANY