

Compact pressure switches for gas and air GW...A6 GW...A6/1

DUNGS[®]
Combustion Controls



Technical description

The pressure switch GW...A6 is an adjustable compact pressure switch according to EN 1854 for combustion plants.

The pressure switches are suitable for **switch-on, switch-off and switch-over of an electric circuit at a variable pressure actual value, relative to the set desired value. The setpoint (switching point) is set on an adjusting wheel with scale.** A test nipple is integrated in the metal housing as standard.

Application

Pressure monitoring in combustion, **ventilation and air-conditioning technologies.** Suitable for gases of families 1,2,3 and other neutral gaseous media.

Approvals

EC type testing certificate as per:

- EC-Gas Appliances Regulation
- **EC-Pressure Equipment Directive**

Pressure switch class „S“ as per EN 1854.

Approvals in other important gas-consuming countries.

Functional description

Single-acting pressure switch in over-pressure range.
 The pressure switches operate without any power supply.

Switching response

GW...A6

Short response time during pressure fluctuations.

GW...A6/1

Slow response time during short-term pressure fluctuations by additional damping nozzle.

GW...A6 pressure switch

The control unit responds to pressure. If the setpoint is exceeded or undershot, **the circuit is switched on, off or over.**

GW... / ...A6 double pressure switch

Combination of two flanged GW...A6 single pressure switches. The two setpoints are set separately and independently. **A combination of different setpoint ranges is therefore possible.** The two control units are fed from the same medium at the medium's pressure.

Switching function

If pressure increases:
 1 NC opens, 2 NO closes.
If pressure drops:
 1 NC closes, 2 NO opens.

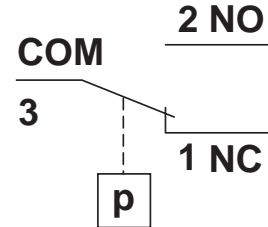

Definition of Δp switching difference

The **Δp switching difference is the pressure difference between the upper and lower switching pressure.**

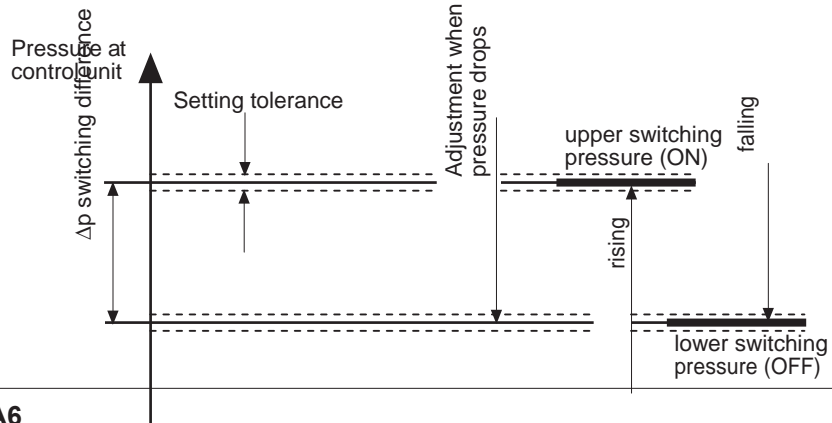

Switching difference Δp @ GW...A5/A6
 Depending on the corresponding set value ($p \downarrow$)

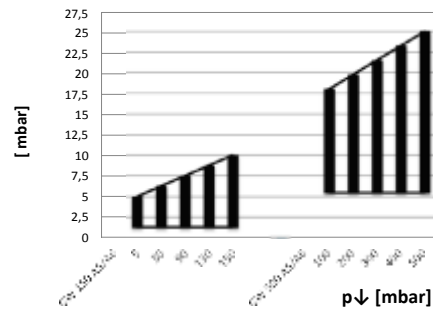
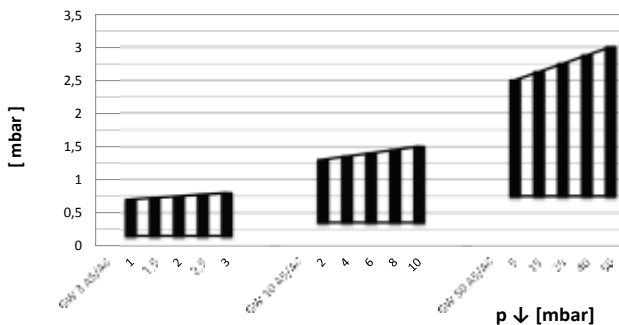

Specifications

Max. operating pressure	GW 3 A6 - GW 150 A6 GW 500 A6	500 mbar 600 mbar	(50 kPa) (60 kPa)
Pressure connection	Standard (V0): Special design (V3):	centrally on housing bottom, G 1/4 inner thread as per ISO 228 additionally G 1/4 inner thread (side right)	
Measuring connection	Test nipple integrated in metal housing $\varnothing 9$		
Temperature range	Ambient temperature -15 °C to +70 °C Medium temperature -15 °C to +70 °C Storage temperature -30 °C to +80 °C		
Materials	Housing: Switch part: Diaphragms: Switching contact:	Aluminium die cast Polyamide NBR Ag	
Switching voltage	AC eff. min. 24 V DC min. 24 V	max. 250 V max. 48 V	
Nominal current	GW 10...500 A6 AC eff. max. 10 A	GW 3 A6 AC eff. max. 6 A	
Switching current	AC eff. max. 6 A at $\cos \varphi 1$ AC eff. max. 3 A at $\cos \varphi 0,6$ AC eff. min. 20 mA DC min. 20 mA DC max. 1 A	AC eff. max. 4 A at $\cos \varphi 1$ AC eff. max. 2 A at $\cos \varphi 0,6$ AC eff. min. 20 mA DC min. 20 mA DC max. 1 A	
Electrical connection	Terminal connection for line sockets as per DIN EN 175 301-803, 3-pin, protection-insulated without ground connection		
Degree of protection	IP 54 as per IEC 529 (EN 60529)		
Setting tolerance	$\pm 15\%$ switch point deviation referred to setpoint, adjusted for dropping pressure, vertical diaphragm position		
Deviation	Permissible deviation of the set value $\leq \pm 15\%$ in the service life test according to EN 1854		

Mounting options GW...A6
Safety solenoid valve
SV-... 505-520

Pressure tap GW...A6 mounting possible ...	
1	no
2	no
3	pe (p ₁)
4	pa (p ₂)

Dimensions [mm]

GW ... A6, A6/1

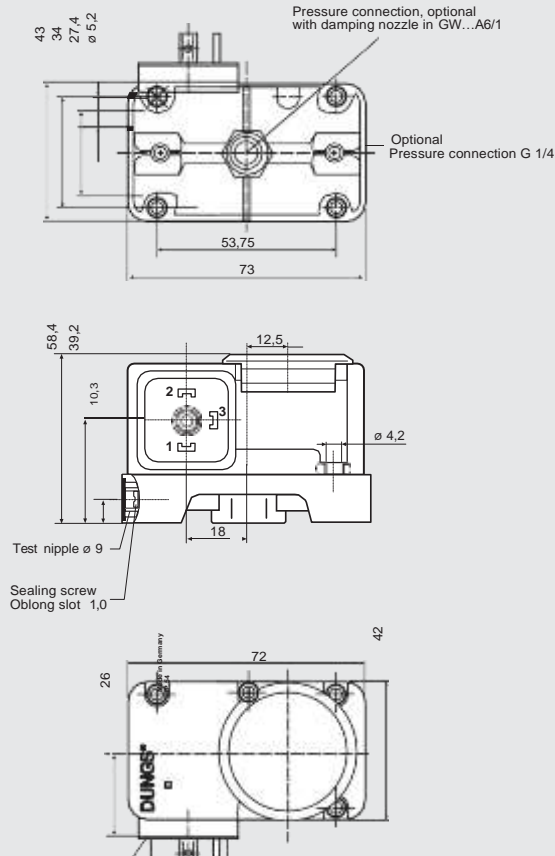

Installation position

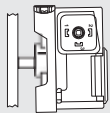

Standard installation position; if a different installation position is used, pay attention to the changed operating points:

- GW 3...50 A6** approx. $\pm 0,6$ mbar
- GW 150 A6** approx. ± 1 mbar
- GW 500 A6** approx. ± 3 mbar

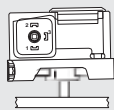

When installed horizontally, the pressure switch switches at a pressure higher.

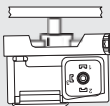

When installed horizontally overhead, the pressure switch switches at a pressure lower.

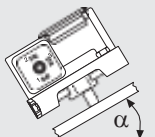

When installed in an intermediate installation position, the pressure switch switches at pressure deviating from the set reference value.

Designation

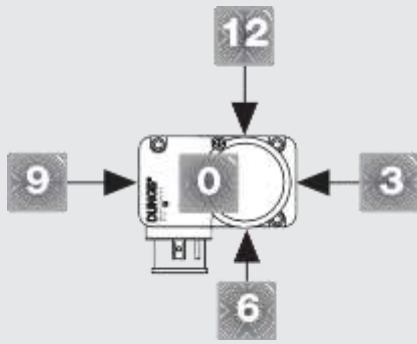

Order example

Pressure switch design

Pressure switch GW...A6

Setting range

0,5 - 15 kPa (5-150 mbar)

Contact material

Ag

Electrical connection

Equipment connector

Pressure connection

G 1/4 at position 0

Test nipple

MS 9

Sealing screw

At position 3

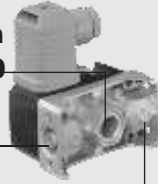

GW 150 A6 [Ag-G3-MS9-V0-VS3]

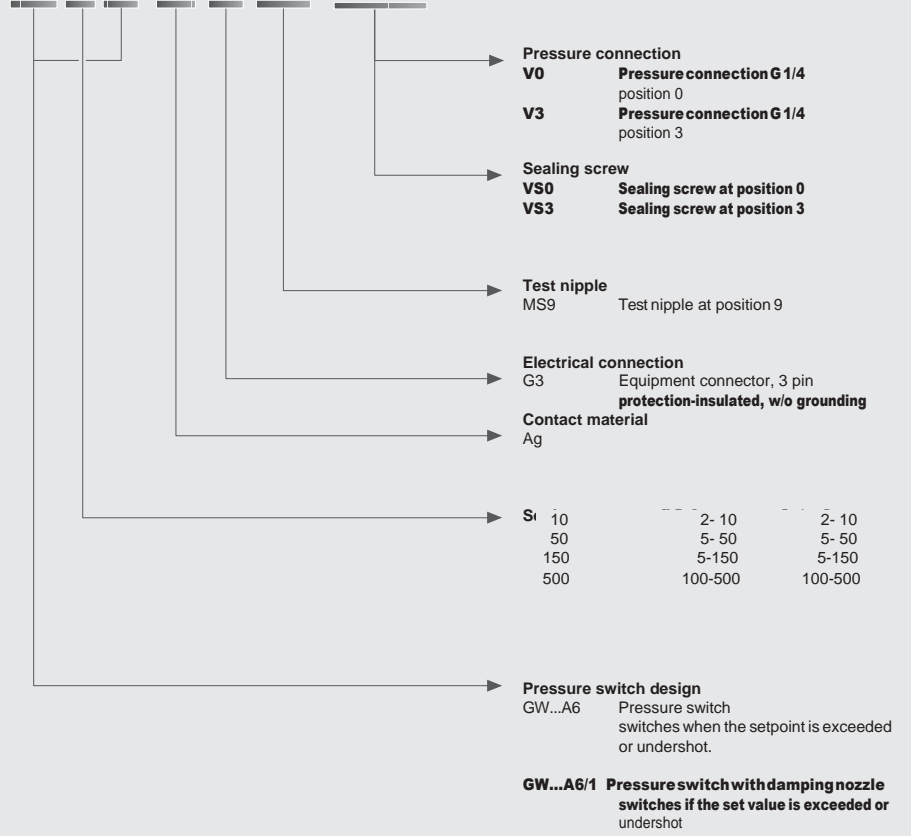

GW 150 A6 [Ag-G3-MS9-V0-VS3]

Accessories for GW A6 pressure switch

Line sockets, 3-pin + grounding, grey GDMW	210 318
Test nipple G 1/4 with sealing ring (1 x)	266 042
Sealing screw G 1/4 with sealing ring (1 x)	266 044
Mounting kit for double pressure switch	213 910
Mounting bracket, metal	230 288
Mounting kit GW...A6 (for fitting to SV)	242 771

Compact pressure switches for gas and air
 GW...A6 GW...A6/1

Double pressure switch

GW... / ...A6



Short technical overview **1 kPa = 10 mbar = 1000 Pa ≈ 100 mm WS**

Type	Design [Ag-G3-MS9-V0]	Order number (1 piece)	Order number (80 pieces)	Setting range [mbar]	max.	Switching difference Δp [mbar]	
						p ↓min.	p ↓max.
GW...A6 pressure switch	GW 3 A6	272 343	228 723	1 - 3	± 15 %	 ≤ 0,7	≤ 0,8
	GW 10 A6	272 620	228 724	2 - 10	± 15 %		≤ 1,3
	GW 50 A6	272 615	228 725	5 - 50	± 15 %		≤ 2,5
	GW 150 A6	272 616	228 726	5 - 150	± 15 %		≤ 5
	GW 500 A6	272 618	228 727	100 - 500	± 15 %		≤ 18

Type	Design [Ag-G3-MS9-V0-VS3]	Order number (1 piece)*	Order number (80 pieces)	Setting range [mbar]	max.	Switching difference Δp [mbar]	
						p ↓min.	p ↓max.
GW...A6 pressure switch	GW 3 A6	231 111	–	1 - 3	± 15 %	 ≤ 0,7	≤ 0,8
	GW 10 A6	231 112	–	2 - 10	± 15 %		≤ 1,3
	GW 50 A6	231 113	–	5 - 50	± 15 %		≤ 2,5
	GW 150 A6	231 114	–	5 - 150	± 15 %		≤ 5
	GW 500 A6	231 115	–	100 - 500	± 15 %		≤ 18

* including line socket

Type	Design [Ag-G3-MS9-V0-VS3]	Order number (1 piece)	Order number (80 pieces)	Setting range [mbar]	max.	Switching difference Δp [mbar]	
						p ↓min.	p ↓max.
GW...A6/1 pressure switch	GW 50 A6/1	275 411	242 676	5 - 50	± 15 %	 ≤ 2,5	≤ 3
	GW 150 A6/1	275 412	242 677	5 - 150	± 15 %		≤ 5
	GW 500 A6/1	275 413	242 678	100 - 500	± 15 %		≤ 18

with damping nozzle 2x