

Yamataha ThermJet Burners

Model TJ0075
Data sheet 5/12/2015

Version 2.7

| Parameter | Burner Velocity | Model TJ0075 | |
|--|--|---------------|-------------|
| Maximum Input, Btu/h (kW)¹ | Medium & High Velocity | 750,000 (198) | |
| Minimum Input, Btu/h (kW)¹ <i>For lower inputs, contact Yamataha, Inc.</i> | Medium & High Velocity | 75,000 (20) | |
| Minimum Input Fixed Air, Btu/h (kW)¹ | Medium & High Velocity | 15,000 (4) | |
| Main Gas Inlet Pressure, "w.c. (mbar) <i>Fuel pressure at gas inlet Tap B (see page 3)</i> | High Velocity | Natural Gas | 13.8 (34.4) |
| | | Propane | 18.3 (45.6) |
| | | Butane | 17.4 (43.3) |
| | Medium Velocity | Natural Gas | 7.2 (17.9) |
| | | Propane | 10.2 (25.4) |
| | | Butane | 9.7 (24.1) |
| Air Inlet Pressure, "w.c. (mbar) <i>15% excess air at maximum input Tap A (see page 3)</i> | High Velocity | Natural Gas | 16.0 (39.8) |
| | | Propane | 16.9 (42.1) |
| | | Butane | 17.0 (42.3) |
| | Medium Velocity | Natural Gas | 9.0 (22.4) |
| | | Propane | 9.3 (23.2) |
| | | Butane | 9.5 (23.7) |
| High Fire Visible Flame Length, inches (mm) <i>Measured from the outlet end of the combustor</i> | High Velocity | Natural Gas | 28 (711) |
| | | Propane | 30 (762) |
| | | Butane | 33 (838) |
| | Medium Velocity | Natural Gas | 28 (711) |
| | | Propane | 38 (965) |
| | | Butane | 38 (965) |
| Approximate Flame Velocity, ft/s (m/s) <i>Approximately 15% excess air at maximum input</i> | High Velocity | 480 (146) | |
| | Medium Velocity | 250 (76) | |
| Maximum Combustion Air Temperature | 300°F (149°C). For higher temperatures use TJPCA (Datasheet 206). | | |
| Flame Detection | Flame rods can be used with all combustors, any fuel listed below, and operating temperatures up to 2,200°F (1,204°C). UV scanners can be used with all combustors, any fuel listed below, and up to the maximum operating temperature. | | |
| Fuels² <i>For any other mixed gas, contact Yamataha, Inc.</i> | Natural gas, Propane or Butane | | |
| Approvals |  | | |

1. All imperial inputs based upon gross calorific values (HHV). All metric inputs based upon net calorific values (LHV).

2. See Design Guide 205 for more information about typical fuel composition and properties.

- All information is based on laboratory testing in neutral (0 "w.c., 0 mbar) pressure chamber. Different chamber conditions may affect the data.
- All information is based on standard combustor design. Changes in combustor will alter performance and pressures.
- All inputs based upon standard conditions; 1 atmosphere, 70°F (21°C).
- Yamataha reserves the right to change the construction and/or configuration of our products at any time without being obliged to adjust earlier supplies accordingly.
- Plumbing of air and gas will affect accuracy of orifice readings. All information is based on generally acceptable air and gas piping practices.

Yamataha

Performance Graphs

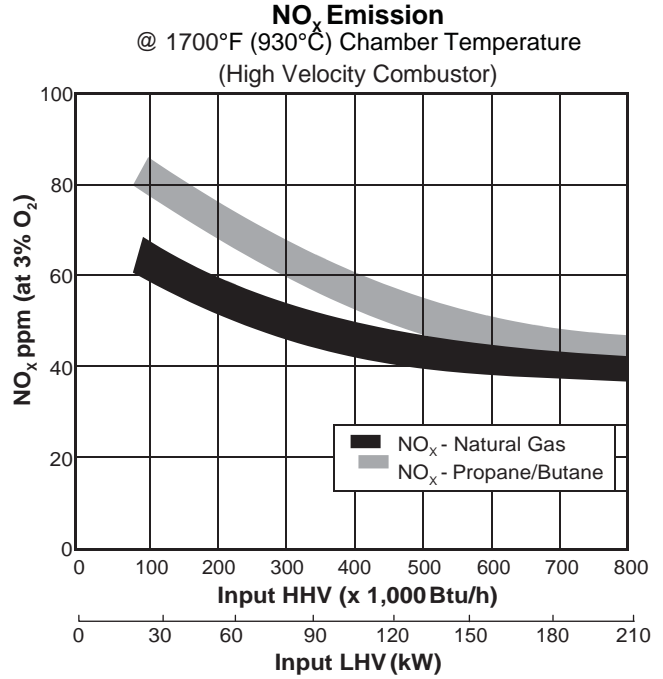
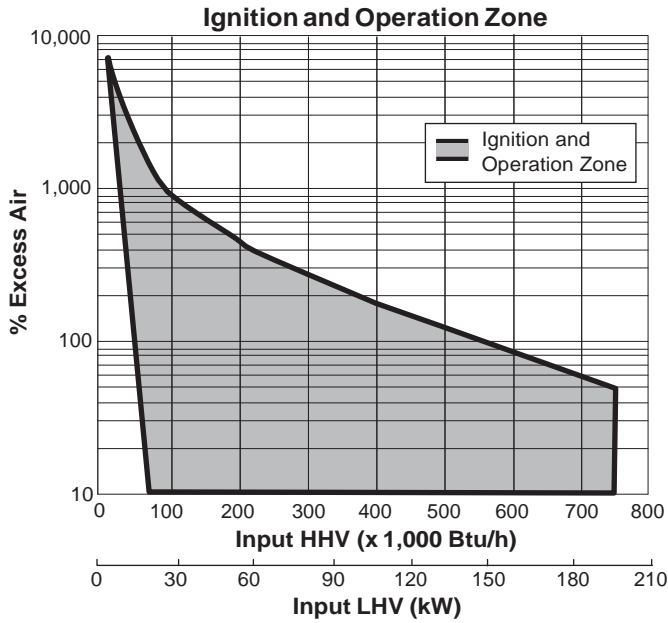

Emission correction factor for medium velocity combustor is 1.20. Emissions data based on, on-ratio control firing at 15% excess air corrected to 3% O₂.

Emissions from the burner are influenced by:

- Fuel type
- Combustion air temperature
- Firing rate
- Chamber conditions
- Percent of excess air

For estimates of other emissions, contact Yamataha.

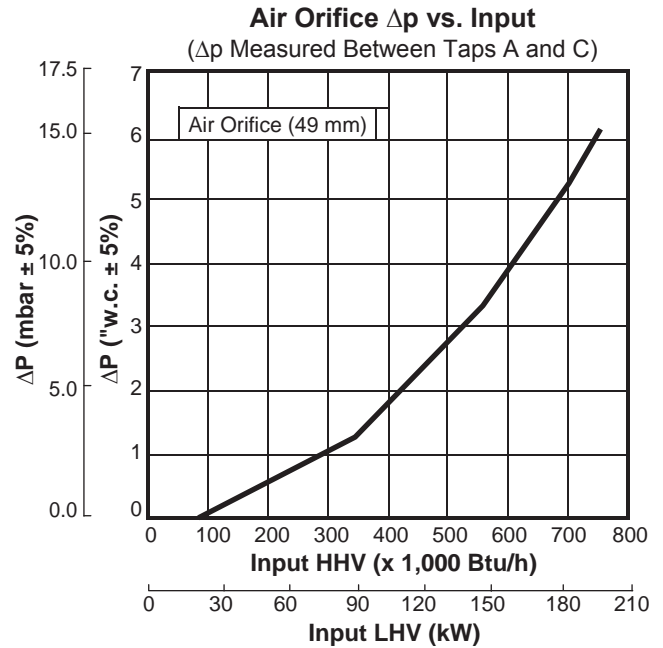
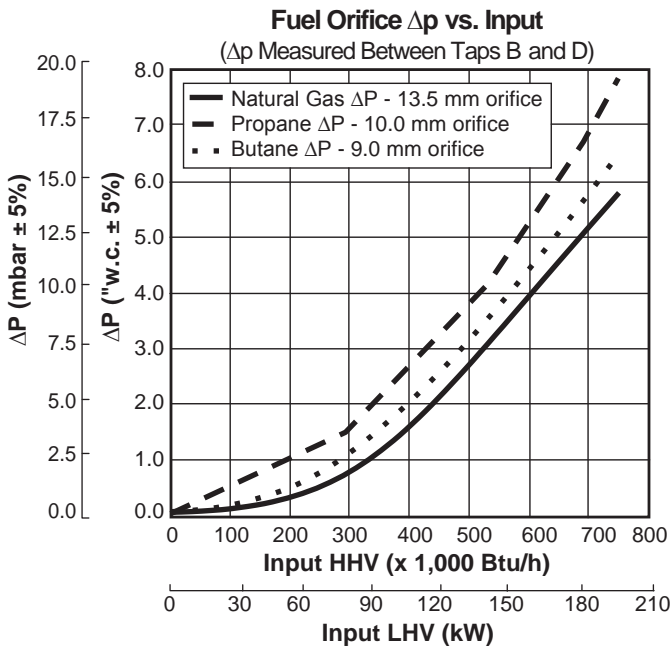

Dimensions and Specifications

Dimensions in mm (inches)

Burner Housing

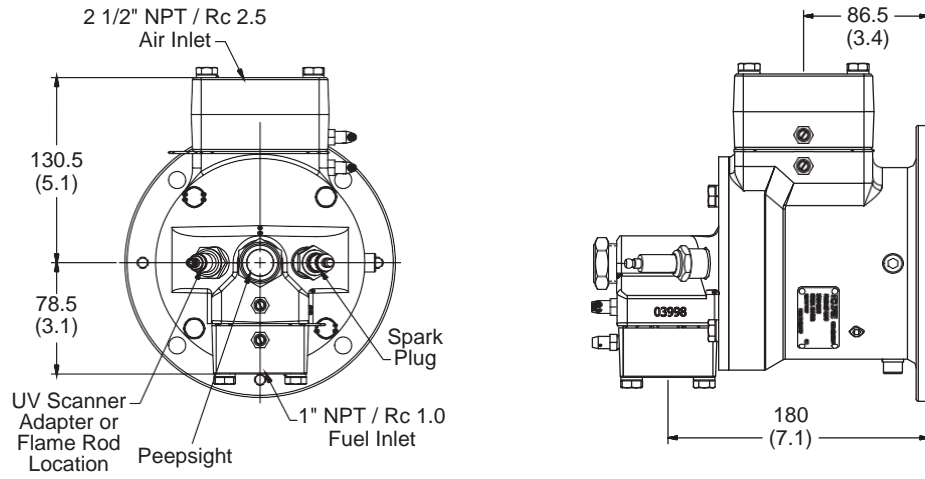

Burner weight less combustor: 37 lbs (17 kg)

Tap Locations

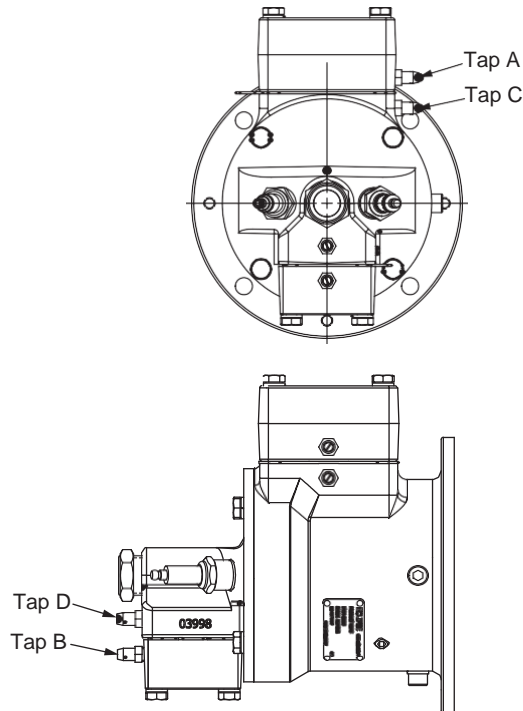

Dimensions and Specifications

Dimensions in mm (inches)

Combustors

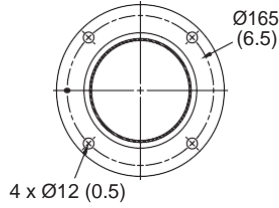
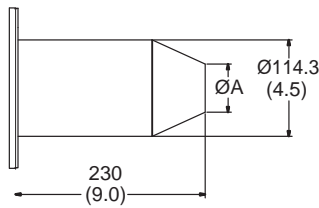

Alloy Combustor (AISI 310)

Weight: 3.0 lbs (1.4 kg)
Maximum Chamber Temp: 1,750°F (950°C)

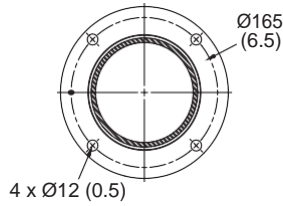
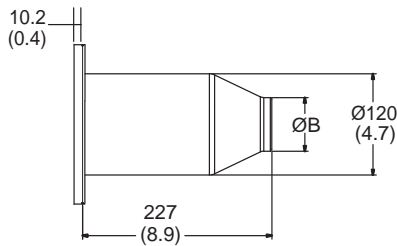

Silicon Carbide Combustor

Weight: 3.3 lbs (1.5 kg)
Maximum Chamber Temp: 2,500°F (1,371°C)

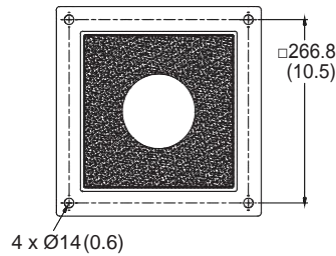
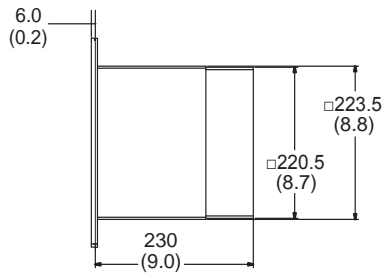

Refractory Combustor with AISI 330 wrapper

Weight: 62.5 lbs (28.3 kg)
Maximum Chamber Temp: 2,800°F (1,538°C)

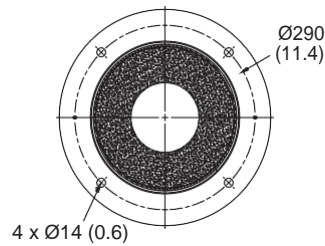
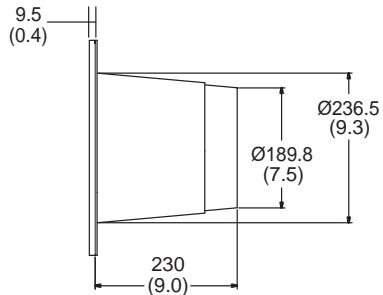

Down Firing Block with AISI 330 wrapper

Weight: 60 lbs (27.2 kg)
Maximum Chamber Temp: 2,800°F (1,538°C)

NOTE: Mounting gasket shown on right side of combustor flange.
Dimensions shown do not account for mounting gasket.

| Dimension | High Velocity | Medium Velocity |
|-----------|---------------|-----------------|
| ØA | Ø57 (2.2) | Ø77.5 (3.1) |
| ØB | Ø63.5 (2.5) | Ø84 (3.3) |